

## GE35-KTT-B INA

Insert bearings

TYPE: Ball bearings, Radial insert bearings, With eccentric locking collar, Spherical outer ring, Series GE..-KTT-B(INA), seals on both side

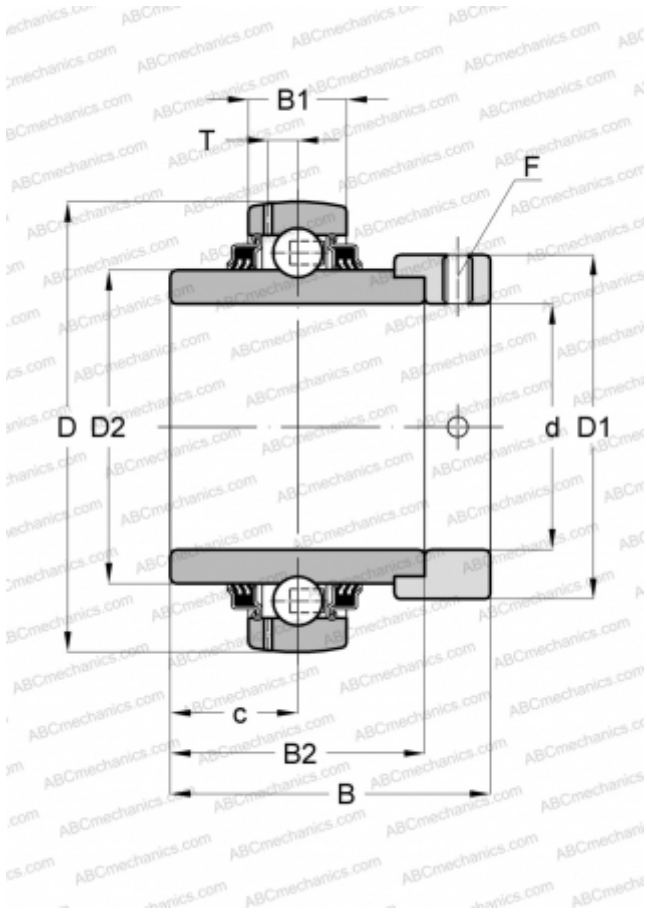

### Technical specification

#### DIMENSIONS, MM

d	35,000
D	72,000
D1	51,000
D2	46,800
B	51,300
B1	19,000
B2	37,700
c	18,800
T	5,600
F	5

#### WEIGHT, KG

0,560

#### MANUFACTURER

[INA](#)

#### REPLACES

GE35-XL-KTT-B