

GE50-KTT-B INA

Insert bearings

TYPE: Ball bearings, Radial insert bearings, With eccentric locking collar, Spherical outer ring, Series GE..-KTT-B(INA), seals on both side

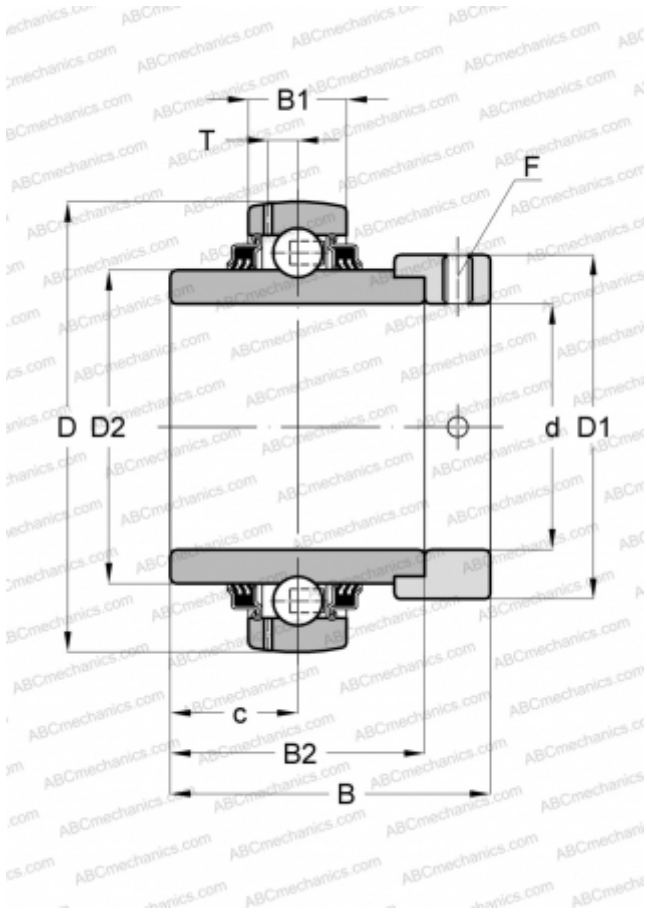

Technical specification

DIMENSIONS, MM

d	50,000
D	90,000
D1	69,000
D2	62,800
B	62,800
B1	22,000
B2	49,200
c	24,600
T	6,900
F	5

WEIGHT, KG

0,980

MANUFACTURER

[INA](#)

REPLACES

GE50-XL-KTT-B