

GE70-KTT-B INA

Insert bearings

TYPE: Ball bearings, Radial insert bearings, With eccentric locking collar, Spherical outer ring, Series GE..-KTT-B(INA), seals on both side

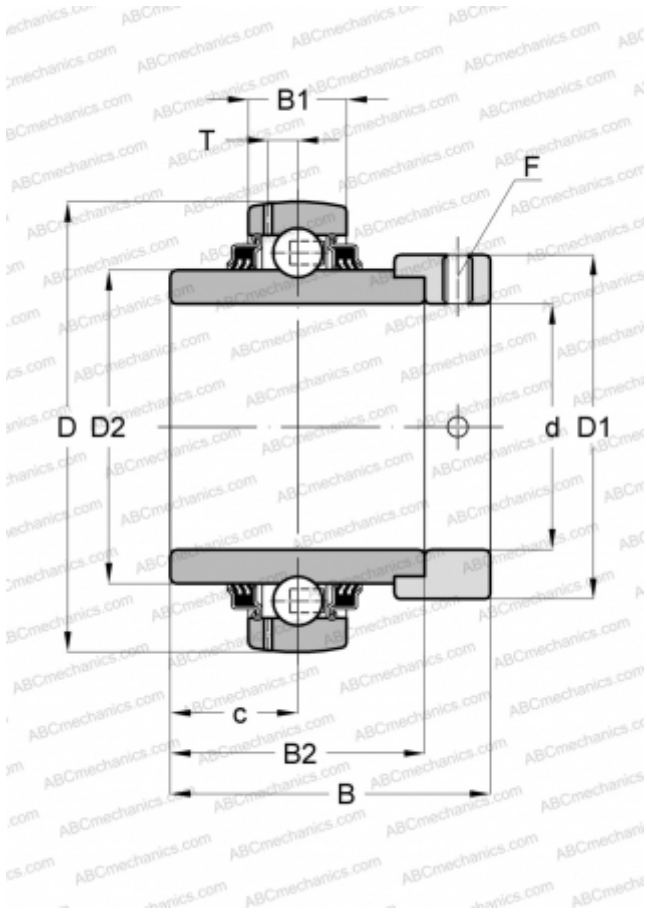

Technical specification

DIMENSIONS, MM

d	70,000
D	125,000
D1	96,000
D2	85,200
B	66,000
B1	28,000
B2	48,500
c	21,500
T	8,900
F	6

WEIGHT, KG

2,150

MANUFACTURER

[INA](#)

REPLACES

GE70-XL-KTT-B