

GE40-KLL-B INA

Insert bearings

TYPE: Ball bearings, Radial insert bearings, With eccentric locking collar, Spherical outer ring, Series GE..-KLL-B(INA), seals on both side

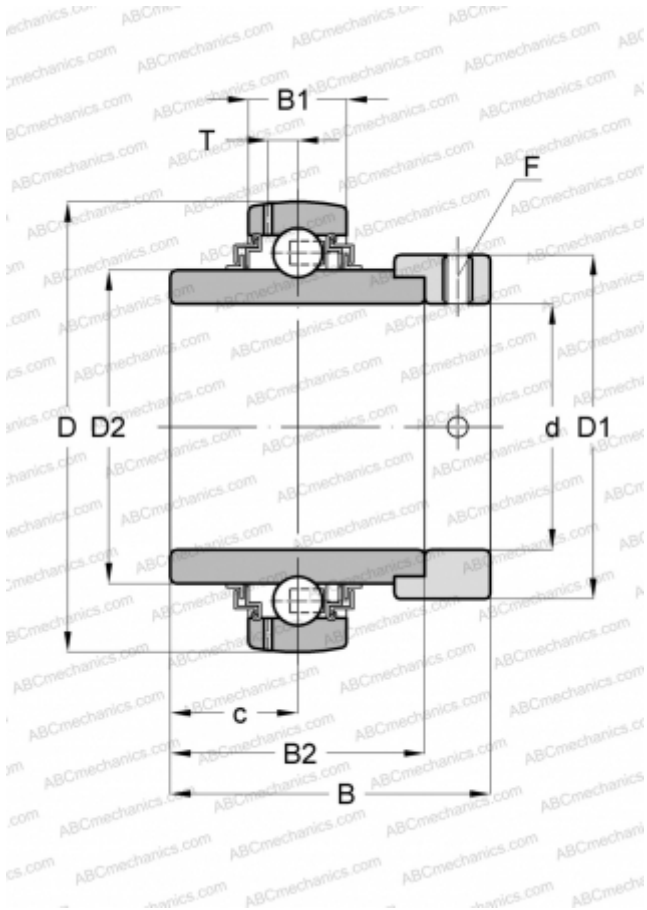

Technical specification

DIMENSIONS, MM

d	40,000
D	80,000
D1	58,000
D2	52,300
B	56,500
B1	21,000
B2	42,900
c	21,400
T	6,400
F	5

WEIGHT, KG

0,750

MANUFACTURER

[INA](#)

REPLACES

GE40-XL-KLL-B