

GE45-KLL-B INA

Insert bearings

TYPE: Ball bearings, Radial insert bearings, With eccentric locking collar, Spherical outer ring, Series GE..-KLL-B(INA), seals on both side

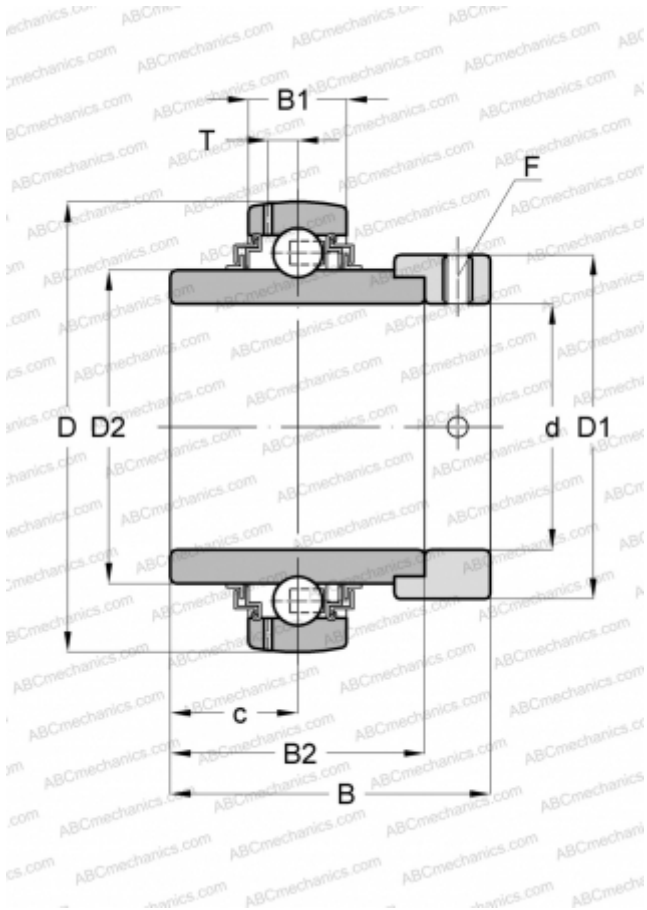

Technical specification

DIMENSIONS, MM

d	45,000
D	85,000
D1	63,000
D2	57,900
B	56,500
B1	22,000
B2	42,900
c	21,400
T	6,400
F	5

WEIGHT, KG

0,840

MANUFACTURER

[INA](#)

REPLACES

GE45-XL-KLL-B