

UG 209-27+ER ASAHI

Insert bearings

TYPE: Ball bearings, Radial insert bearings, With eccentric locking collar, Spherical outer ring, Series UG, seals on both side, inch size

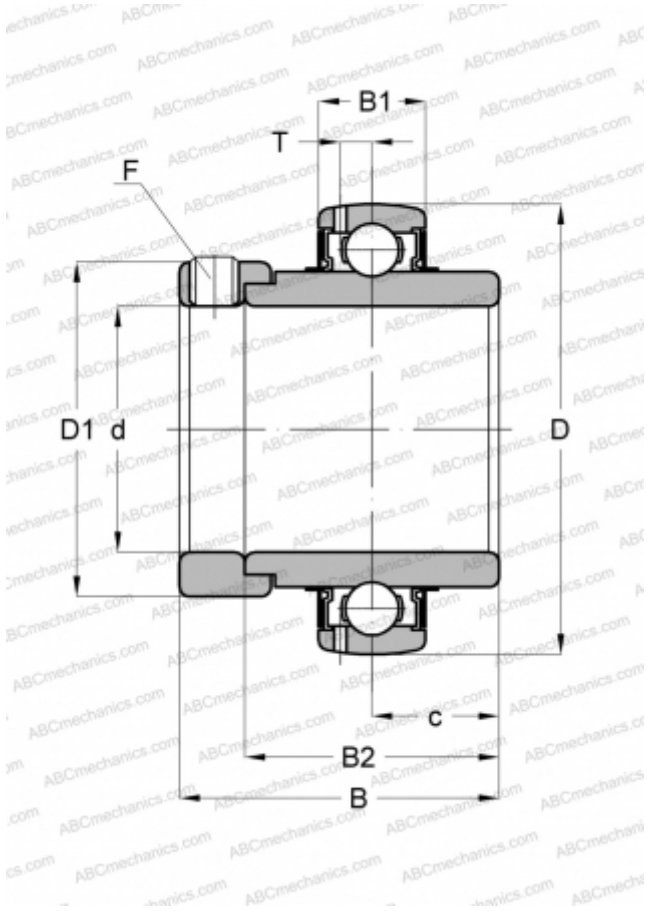

Technical specification

DIMENSIONS, MM

d	42,862
D	85,004
D1	63,500
B	56,356
B1	21,996
B2	42,862
c	21,430
T	6,502
F	3/8-24

WEIGHT, KG

0,783

MANUFACTURER

[ASAHI](#)