

E25-KRR INA

Insert bearings

TYPE: Ball bearings, Radial insert bearings, With eccentric locking collar, Cylindrical outer ring, Series E..-KRR(INA), seals on both side

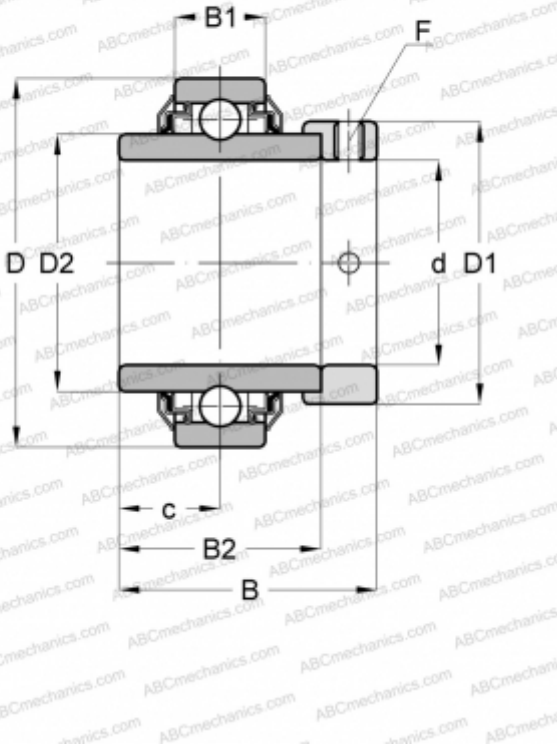

Technical specification

DIMENSIONS, MM

d	25,000
D	52,000
D1	37,500
D2	33,800
B	44,500
B1	15,000
B2	34,900
c	17,500
F	3

WEIGHT, KG

0,250

MANUFACTURER

[INA](#)

REPLACES

E25-XL-KRR