

AY15-NPP-B INA

Insert bearings

TYPE: Ball bearings, Radial insert bearings, Grub screw to inner ring, Spherical outer ring, Series AY...-NPP-B(INA), seals on both side

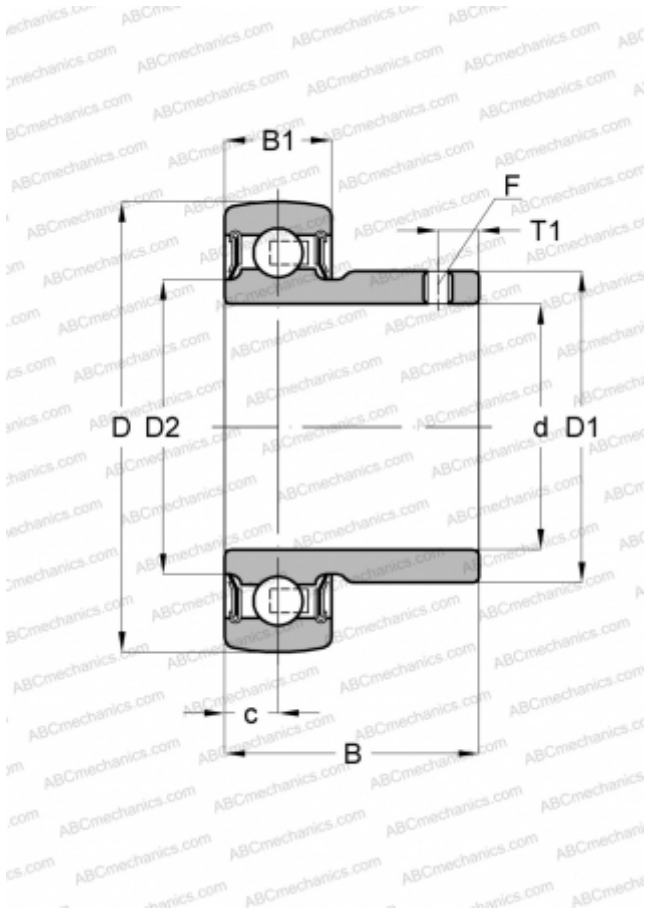

Technical specification

DIMENSIONS, MM

d	15,000
D	40,000
D1	23,900
D2	22,900
B	22,000
B1	12,000
c	6,000
T1	4,000
F	2.5

WEIGHT, KG

0,090

MANUFACTURER

[INA](#)

REPLACES

AY15-XL-NPP-B