

AY20-NPP-B INA

Insert bearings

TYPE: Ball bearings, Radial insert bearings, Grub screw to inner ring, Spherical outer ring, Series AY...-NPP-B(INA), seals on both side

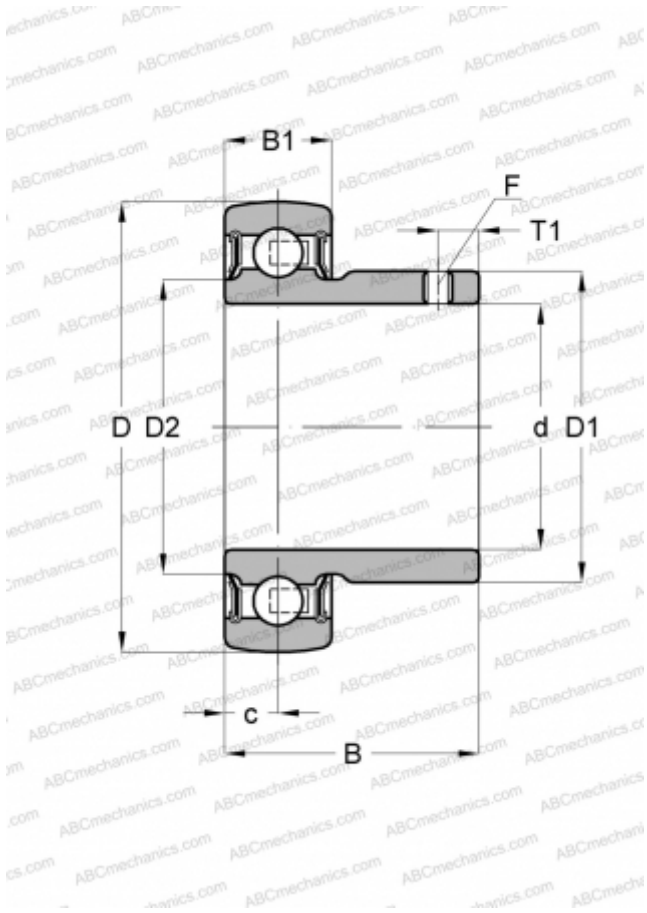

Technical specification

DIMENSIONS, MM

d	20,000
D	47,000
D1	28,300
D2	26,700
B	25,000
B1	14,000
c	7,000
T1	4,500
F	2.5

WEIGHT, KG

0,130

MANUFACTURER

[INA](#)

REPLACES

AY20-XL-NPP-B