

AY25-NPP-B INA

Insert bearings

TYPE: Ball bearings, Radial insert bearings, Grub screw to inner ring, Spherical outer ring, Series AY...-NPP-B(INA), seals on both side

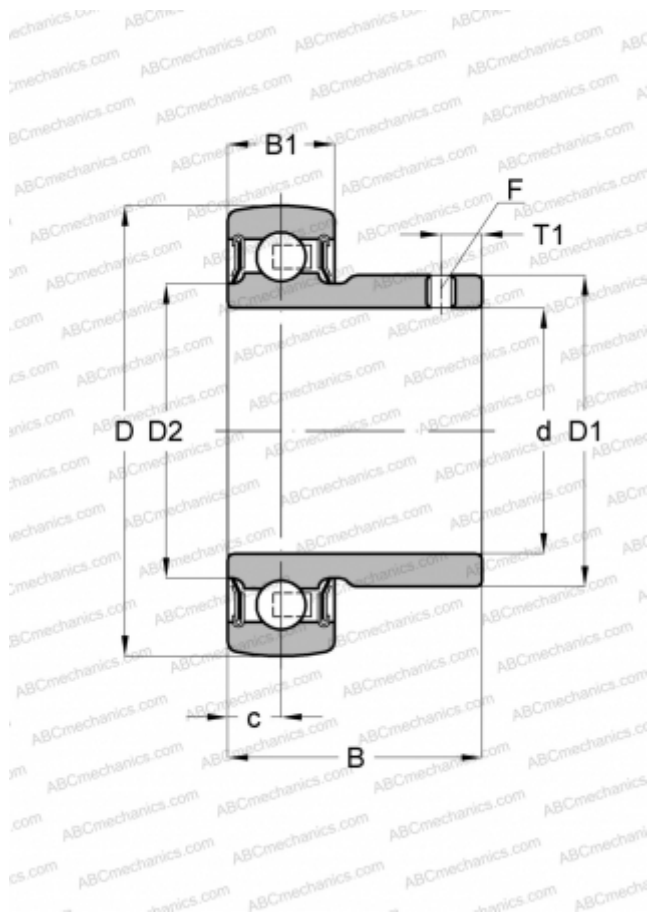

Technical specification

DIMENSIONS, MM

d	25,000
D	52,000
D1	33,500
D2	30,400
B	27,000
B1	15,000
c	7,500
T1	5,000
F	2.5

WEIGHT, KG

0,160

MANUFACTURER

[INA](#)

REPLACES

AY25-XL-NPP-B