

GYE16-KRR-B INA

Insert bearings

TYPE: Ball bearings, Radial insert bearings, Grub screw to inner ring, Spherical outer ring, Series GYE...-KRR-B(INA), seals on both side

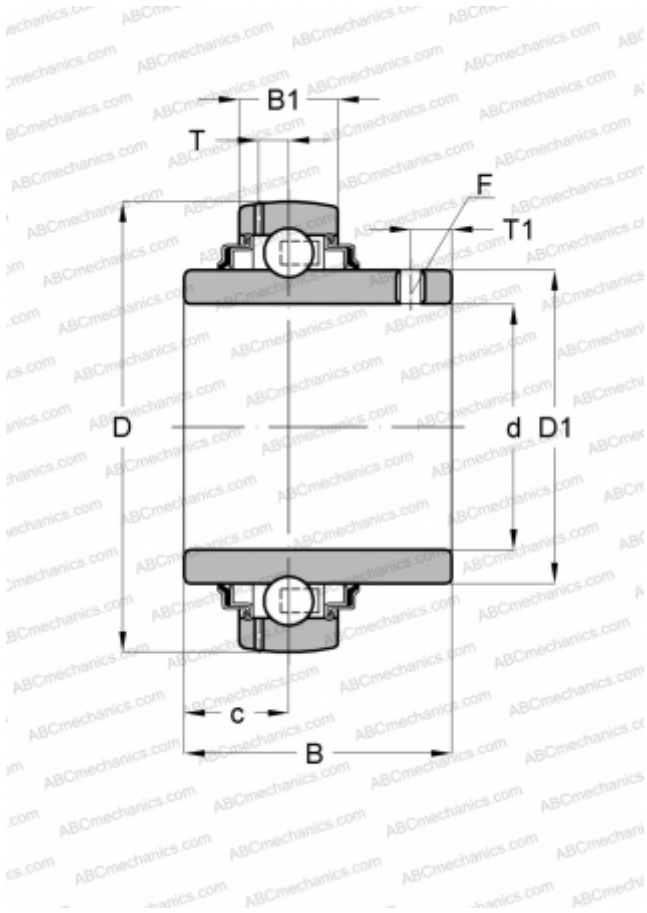

Technical specification

DIMENSIONS, MM

d	16,000
D	40,000
D1	23,900
B	27,400
B1	12,000
c	11,500
T	3,400
T1	4,000
F	2.5

WEIGHT, KG

0,090

MANUFACTURER

[INA](#)

REPLACES

GYE16-XL-KRR-B