

GYE20-KRR-B INA

Insert bearings

TYPE: Ball bearings, Radial insert bearings, Grub screw to inner ring, Spherical outer ring, Series GYE...-KRR-B(INA), seals on both side

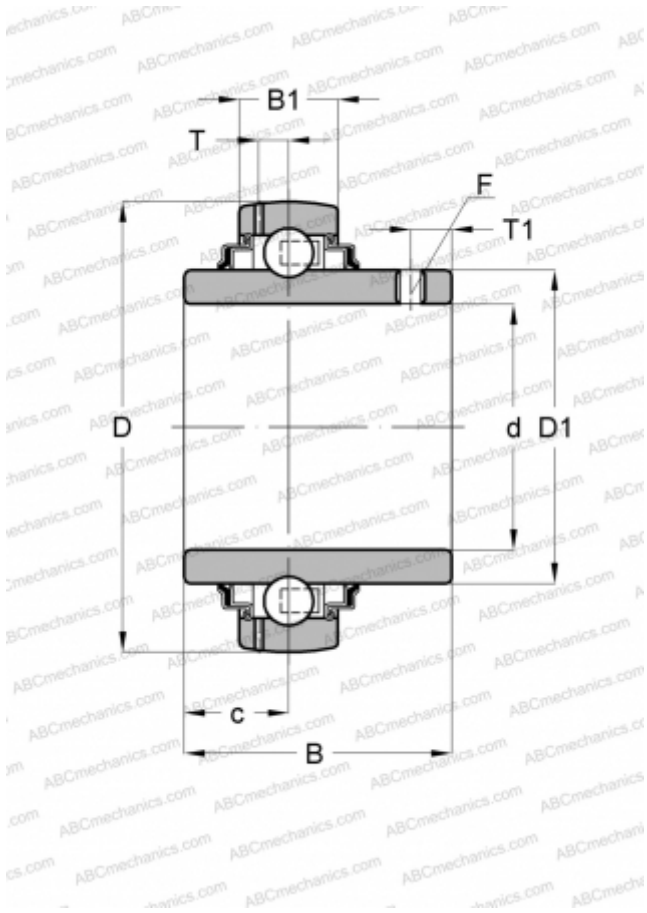

Technical specification

DIMENSIONS, MM

d	20,000
D	47,000
D1	27,600
B	31,000
B1	14,000
c	12,700
T	4,000
T1	4,500
F	2.5

WEIGHT, KG

0,140

MANUFACTURER

[INA](#)

REPLACES

GYE20-XL-KRR-B