

## GYE35-KRR-B INA

Insert bearings

TYPE: Ball bearings, Radial insert bearings, Grub screw to inner ring, Spherical outer ring, Series GYE...-KRR-B(INA), seals on both side

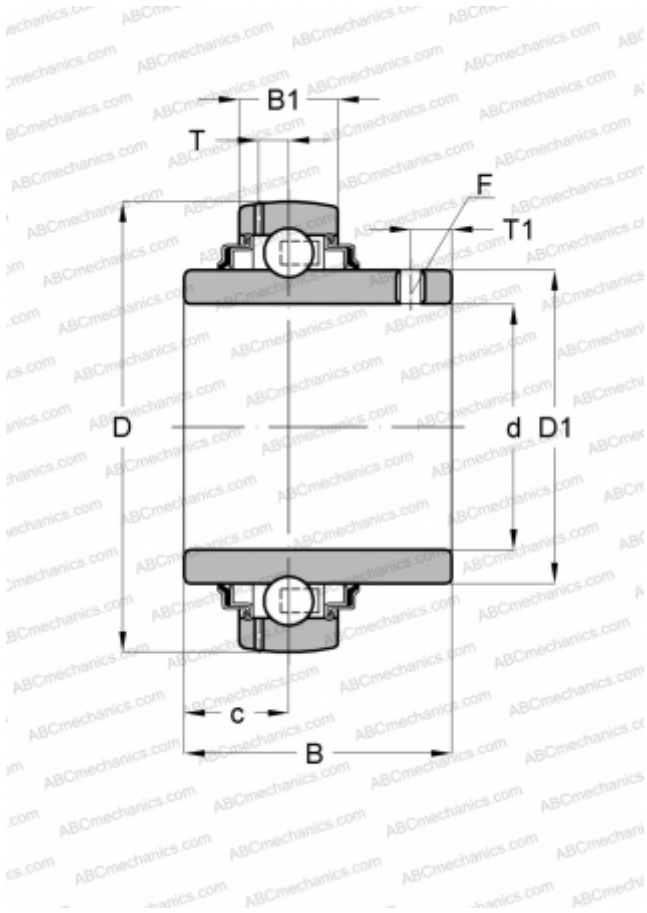

### Technical specification

#### DIMENSIONS, MM

d	35,000
D	72,000
D1	46,800
B	42,900
B1	19,000
c	17,500
T	5,600
T1	6,000
F	3

#### WEIGHT, KG

0,460

#### MANUFACTURER

[INA](#)

#### REPLACES

GYE35-XL-KRR-B