

## GYE40-KRR-B INA

Insert bearings

TYPE: Ball bearings, Radial insert bearings, Grub screw to inner ring, Spherical outer ring, Series GYE...-KRR-B(INA), seals on both side

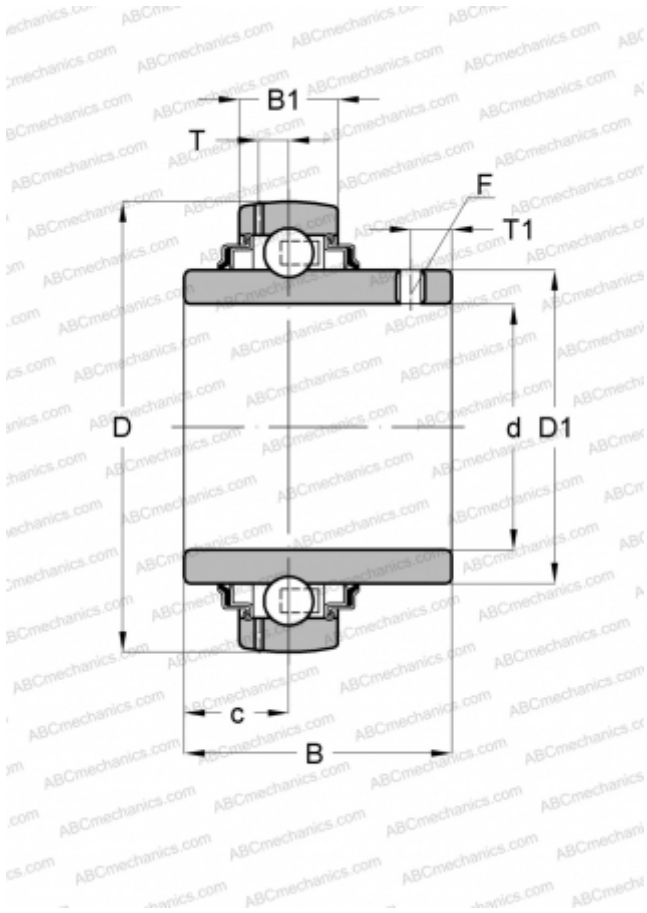

### Technical specification

#### DIMENSIONS, MM

d	40,000
D	80,000
D1	52,300
B	49,200
B1	21,000
c	19,000
T	6,400
T1	8,000
F	4

#### WEIGHT, KG

0,620

#### MANUFACTURER

[INA](#)

#### REPLACES

GYE40-XL-KRR-B