

GYE50-KRR-B INA

Insert bearings

TYPE: Ball bearings, Radial insert bearings, Grub screw to inner ring, Spherical outer ring, Series GYE...-KRR-B(INA), seals on both side

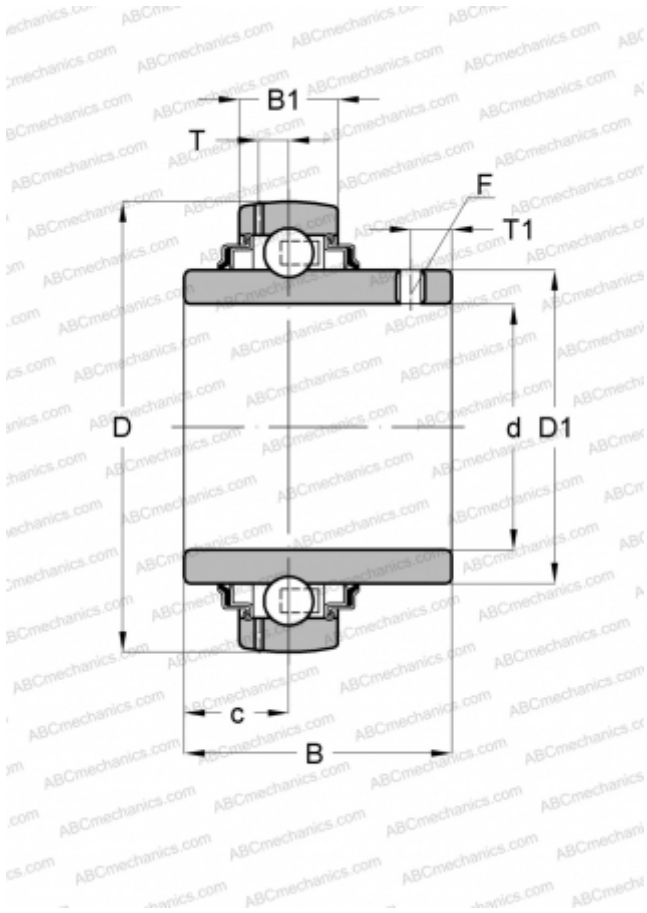

Technical specification

DIMENSIONS, MM

d	50,000
D	90,000
D1	62,800
B	51,600
B1	22,000
c	19,000
T	6,900
T1	8,500
F	4

WEIGHT, KG

0,790

MANUFACTURER

[INA](#)

REPLACES

GYE50-XL-KRR-B