

GYE55-KRR-B INA

Insert bearings

TYPE: Ball bearings, Radial insert bearings, Grub screw to inner ring, Spherical outer ring, Series GYE...-KRR-B(INA), seals on both side

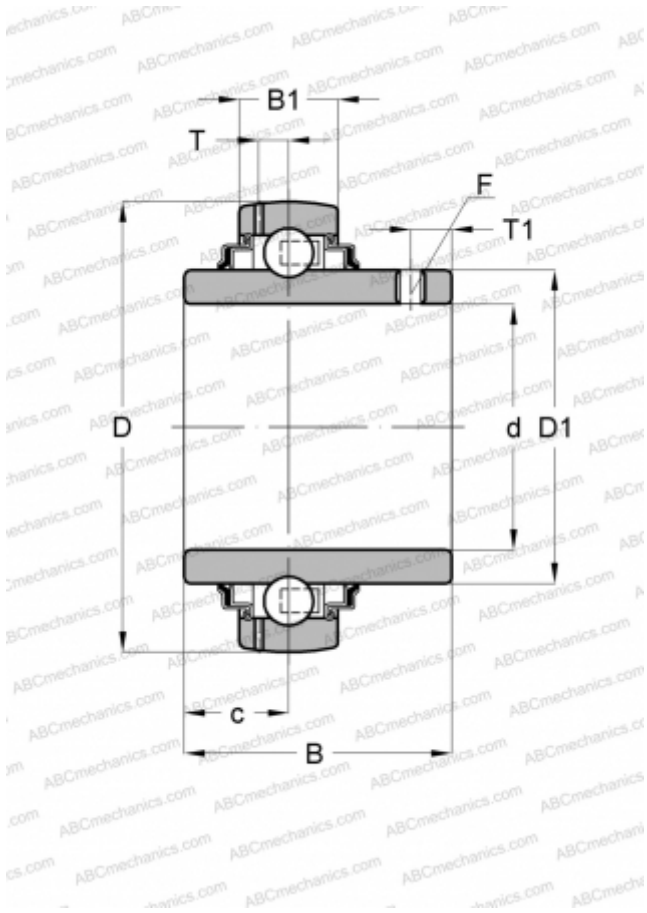

Technical specification

DIMENSIONS, MM

d	55,000
D	100,000
D1	69,800
B	55,600
B1	25,000
c	22,200
T	7,000
T1	9,000
F	4

WEIGHT, KG

1,080

MANUFACTURER

[INA](#)

REPLACES

GYE55-XL-KRR-B