

## GYE60-KRR-B INA

Insert bearings

TYPE: Ball bearings, Radial insert bearings, Grub screw to inner ring, Spherical outer ring, Series GYE...-KRR-B(INA), seals on both side

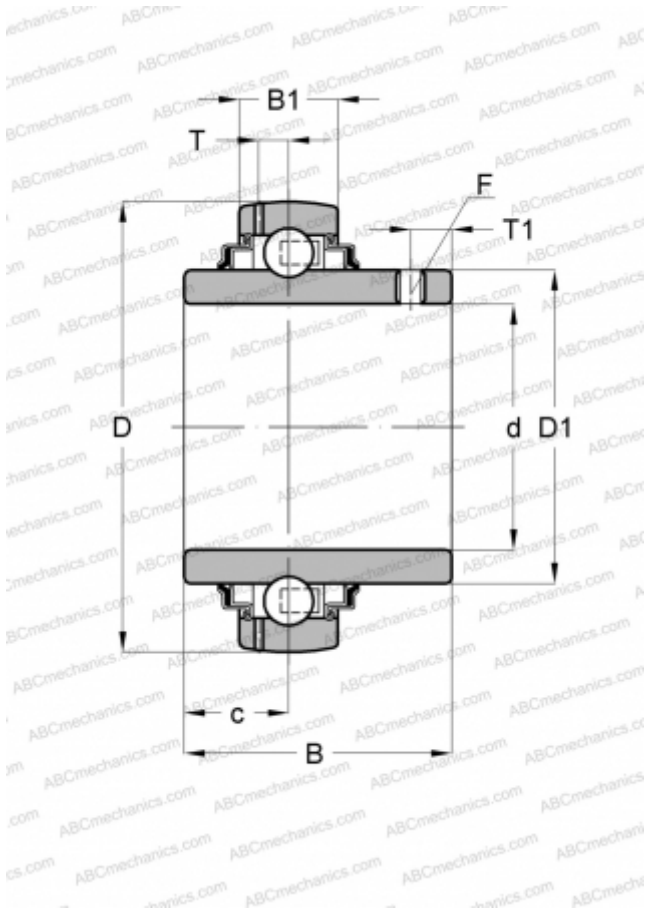

### Technical specification

#### DIMENSIONS, MM

d	60,000
D	110,000
D1	76,500
B	65,100
B1	24,000
c	25,400
T	7,200
T1	10,100
F	5

#### WEIGHT, KG

1,460

#### MANUFACTURER

[INA](#)

#### REPLACES

GYE60-XL-KRR-B