

GYE70-KRR-B INA

Insert bearings

TYPE: Ball bearings, Radial insert bearings, Grub screw to inner ring, Spherical outer ring, Series GYE...-KRR-B(INA), seals on both side

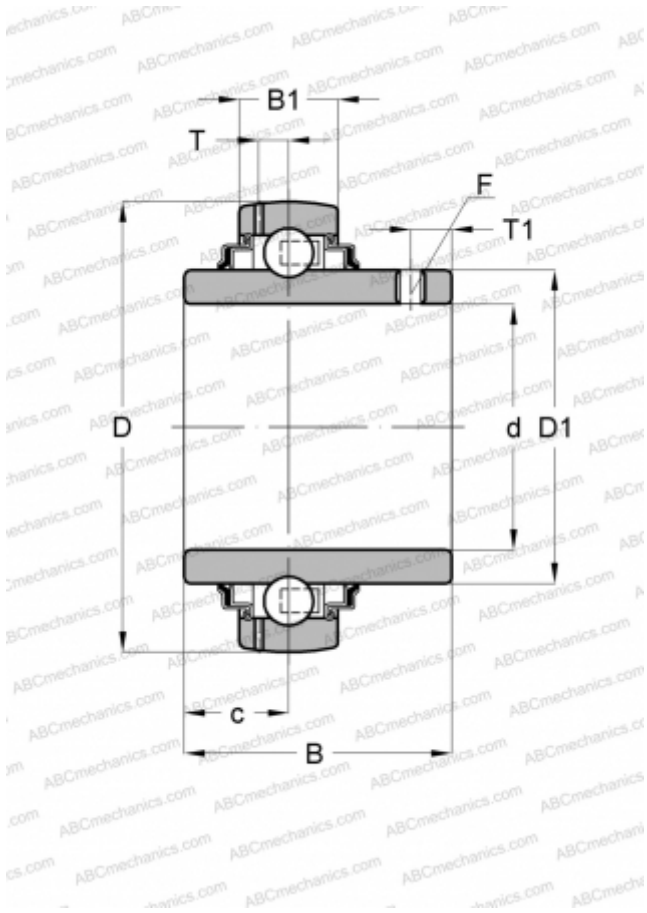

Technical specification

DIMENSIONS, MM

d	70,000
D	125,000
D1	85,200
B	74,600
B1	28,000
c	30,200
T	8,900
T1	12,000
F	5

WEIGHT, KG

1,950

MANUFACTURER

[INA](#)

REPLACES

GYE70-XL-KRR-B