

GYE75-KRR-B INA

Insert bearings

TYPE: Ball bearings, Radial insert bearings, Grub screw to inner ring, Spherical outer ring, Series GYE...-KRR-B(INA), seals on both side

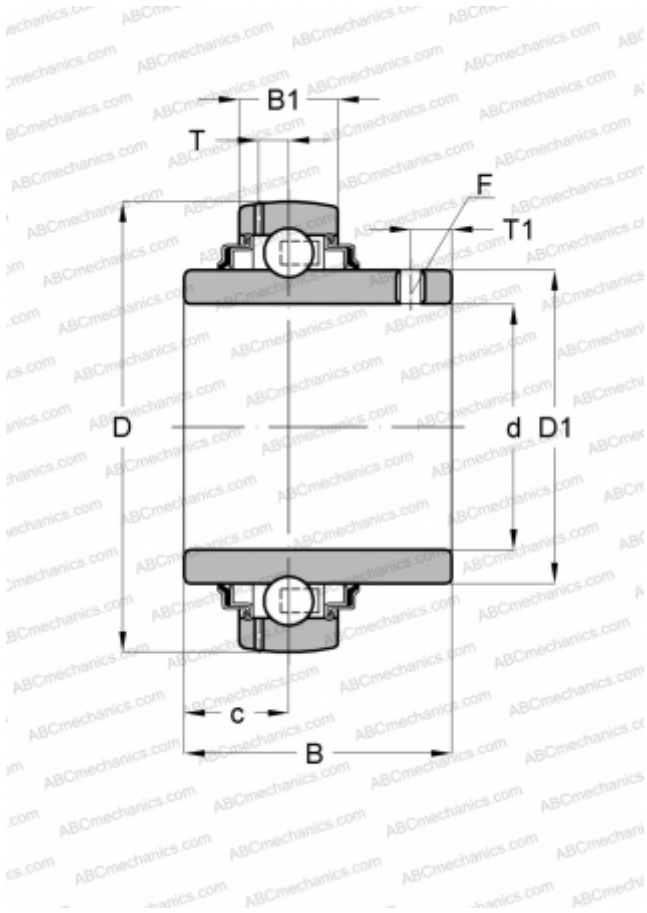

Technical specification

DIMENSIONS, MM

d	75,000
D	130,000
D1	90,000
B	77,800
B1	28,000
c	33,300
T	8,500
T1	12,700
F	5

WEIGHT, KG

2,070

MANUFACTURER

[INA](#)

REPLACES

GYE75-XL-KRR-B