

GYE80-KRR-B INA

Insert bearings

TYPE: Ball bearings, Radial insert bearings, Grub screw to inner ring, Spherical outer ring, Series GYE...-KRR-B(INA), seals on both side

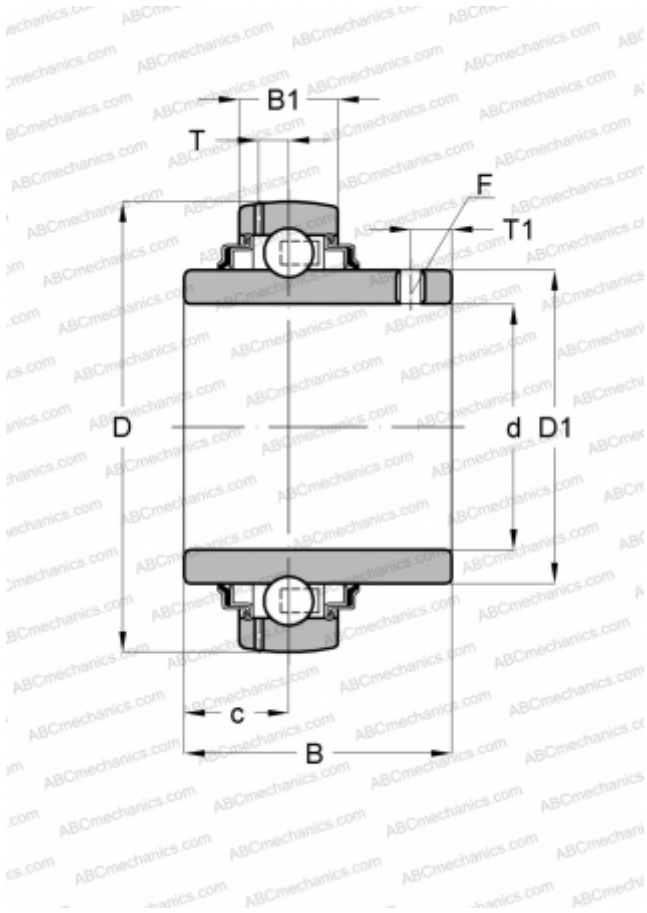

Technical specification

DIMENSIONS, MM

d	80,000
D	140,000
D1	97,000
B	82,600
B1	30,000
c	33,300
T	8,800
T1	12,000
F	5

WEIGHT, KG

2,700

MANUFACTURER

[INA](#)

REPLACES

GYE80-XL-KRR-B