

GYE25-KRR-B-VA INA

Insert bearings

TYPE: Ball bearings, Radial insert bearings, Grub screw to inner ring, Spherical outer ring, Series GYE...-KRR-B(INA), seals on both side, corrosion resistant

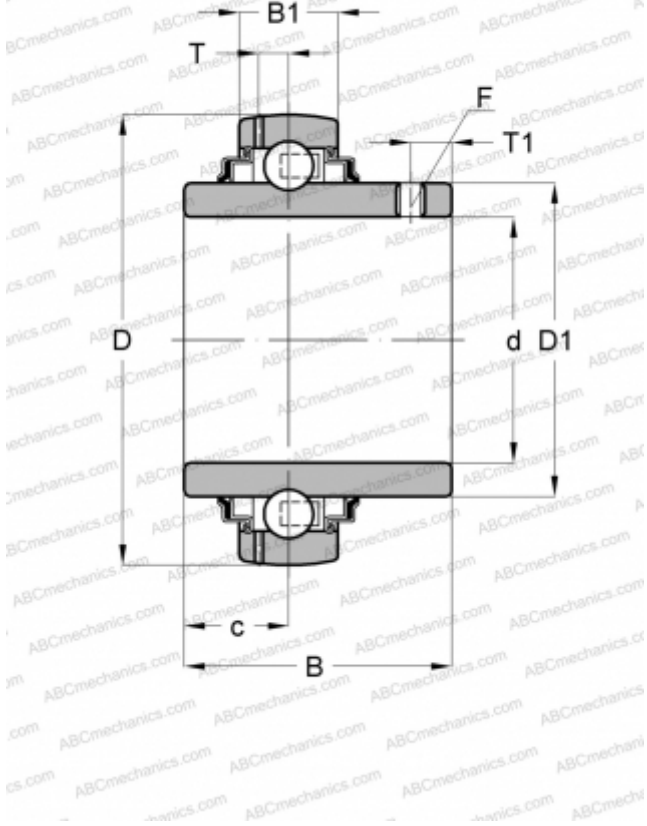

Technical specification

DIMENSIONS, MM

d	25,000
D	52,000
D1	34,030
B	34,100
B1	17,000
c	14,300
T	4,150
T1	5,000
F	2.5

WEIGHT, KG

0,210

MANUFACTURER

[INA](#)

REPLACES

GYE25-XL-KRR-B-VA