

GY1108-KRR-B-AS2/V INA

Insert bearings

TYPE: Ball bearings, Radial insert bearings, Grub screw to inner ring, Spherical outer ring, Series GY..-KRR-B-AS2/V(INA), seals on both side, 2 lubrication hole offset on both side, inch

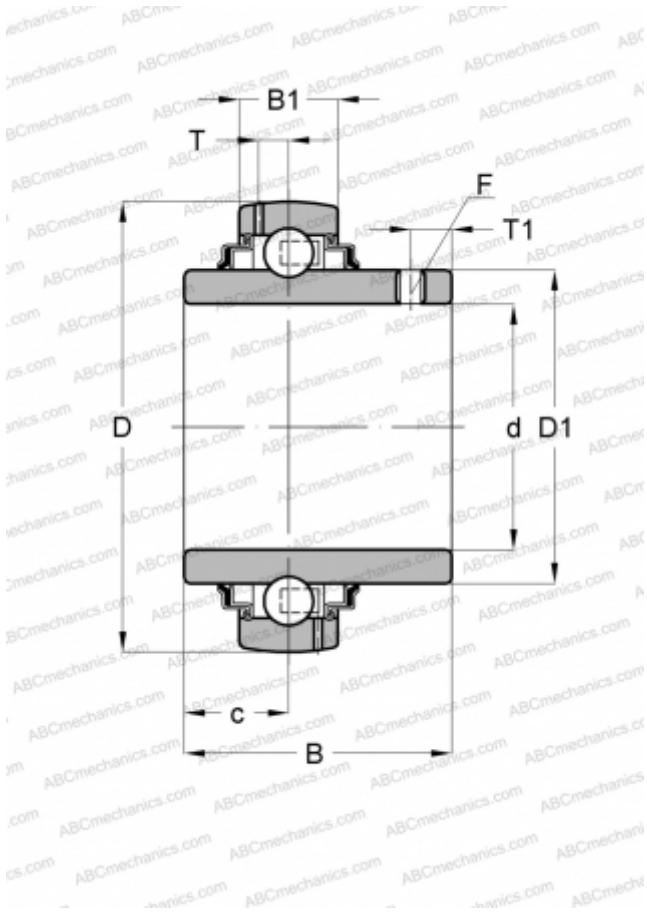

Technical specification

DIMENSIONS, MM

d	38,100
D	80,000
D1	52,300
B	49,200
B1	21,000
c	19,000
T	21,000
T1	8,000
F	3.968

WEIGHT, KG

0,650

MANUFACTURER

[INA](#)