

UC 201 ASAHI

Insert bearings

TYPE: Ball bearings, Radial insert bearings, Grub screw to inner ring, Spherical outer ring, Series UC, seals on both side

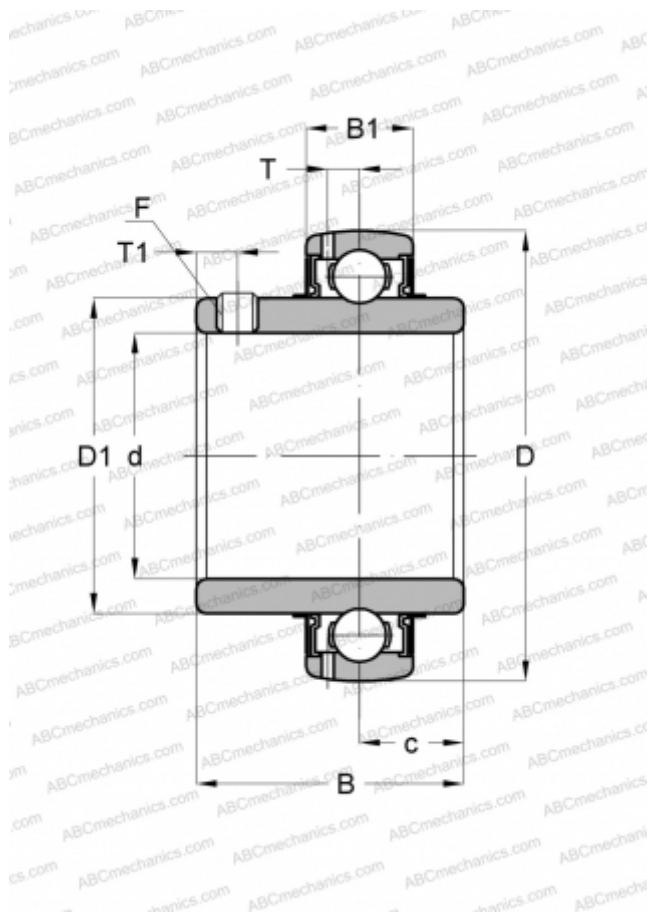

Technical specification

DIMENSIONS, MM

d	12,000
D	47,000
D1	29,000
B	31,000
B1	17,000
c	12,700
T	4,500
T1	4,500
F	M6 x 0.75

WEIGHT, KG

0,210

MANUFACTURER

[ASAHI](#)