

UC 206 ASAHI

Insert bearings

TYPE: Ball bearings, Radial insert bearings, Grub screw to inner ring, Spherical outer ring, Series UC, seals on both side

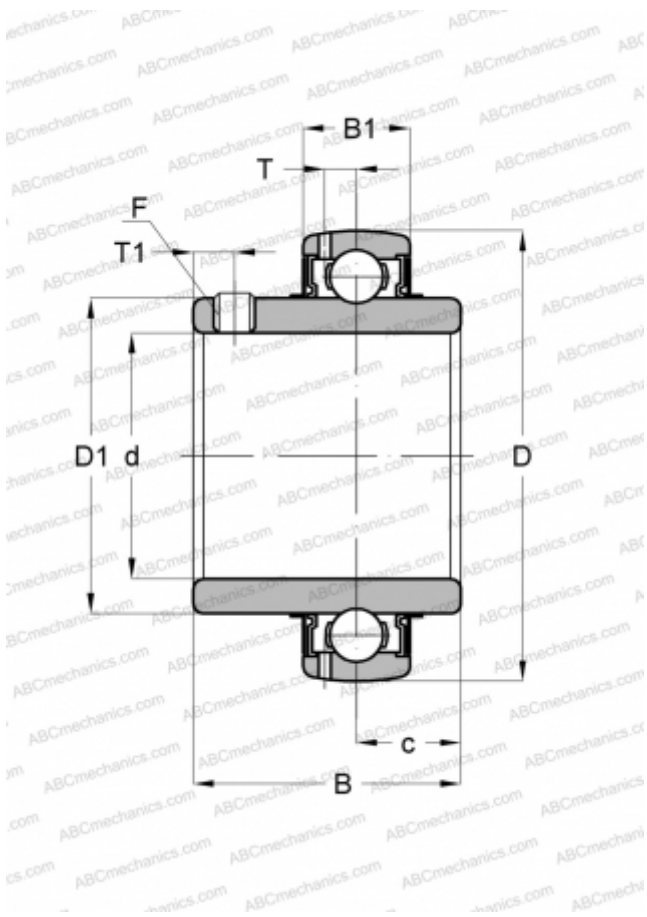

Technical specification

DIMENSIONS, MM

d	30,000
D	62,000
D1	40,500
B	38,100
B1	19,000
c	15,900
T	5,100
T1	5,000
F	M6 x 0.75

WEIGHT, KG

0,310

MANUFACTURER

[ASAHI](#)