

## UC 212 ASAHI

Insert bearings

TYPE: Ball bearings, Radial insert bearings, Grub screw to inner ring, Spherical outer ring, Series UC, seals on both side

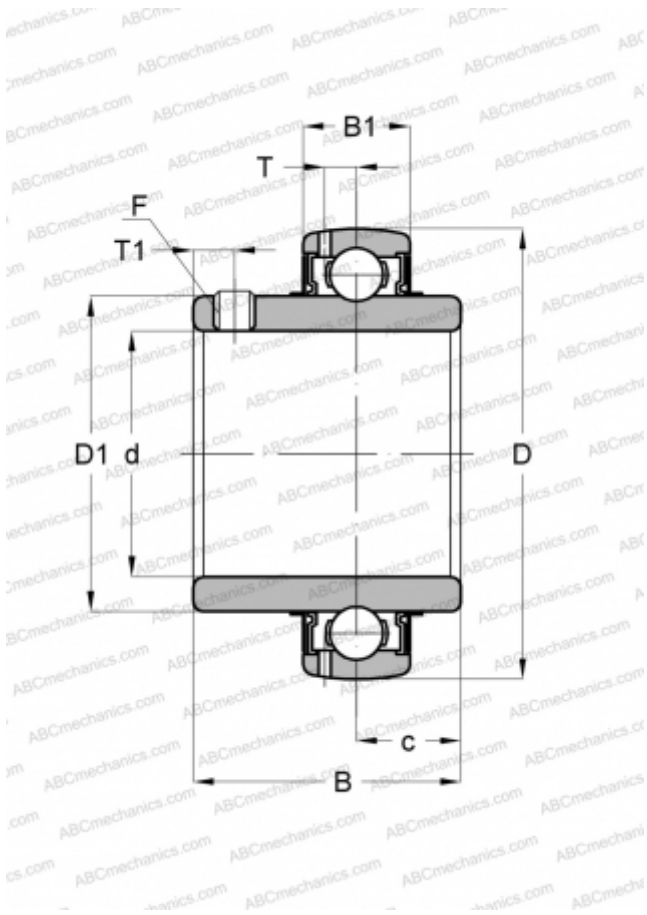

### Technical specification

#### DIMENSIONS, MM

d	60,000
D	1,000
D1	77,000
B	65,100
B1	26,000
c	25,400
T	7,700
T1	10,000
F	M10 x 1.25

#### WEIGHT, KG

1,450

#### MANUFACTURER

[ASAHI](#)