

## UC 213 ASAHI

Insert bearings

TYPE: Ball bearings, Radial insert bearings, Grub screw to inner ring, Spherical outer ring, Series UC, seals on both side

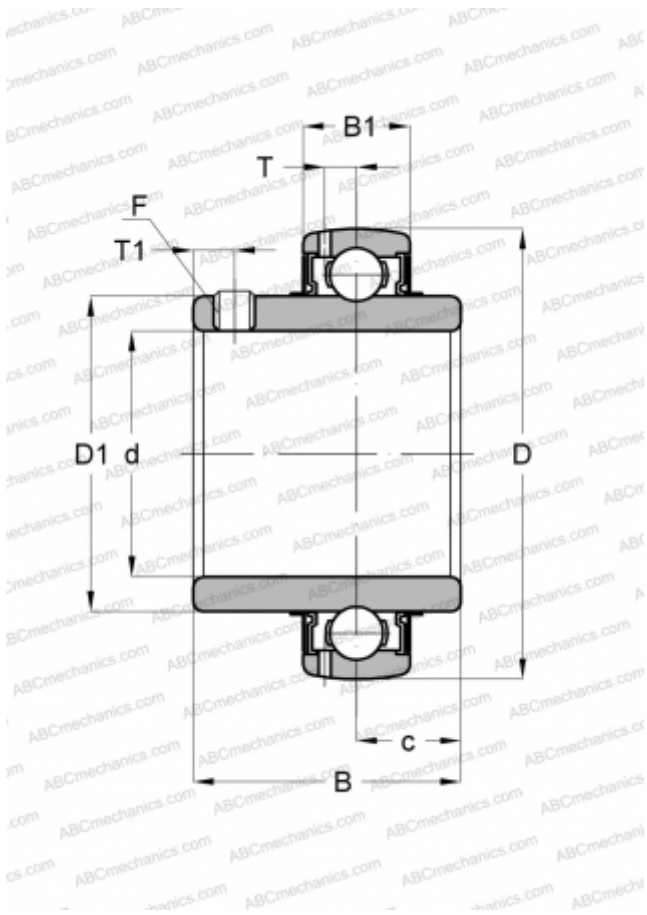

### Technical specification

#### DIMENSIONS, MM

d	65,000
D	120,000
D1	82,100
B	65,100
B1	27,000
c	25,400
T	8,300
T1	10,000
F	M10 x 1.25

#### WEIGHT, KG

1,710

#### MANUFACTURER

[ASAHI](#)