

## UC 215 ASAHI

Insert bearings

TYPE: Ball bearings, Radial insert bearings, Grub screw to inner ring, Spherical outer ring, Series UC, seals on both side

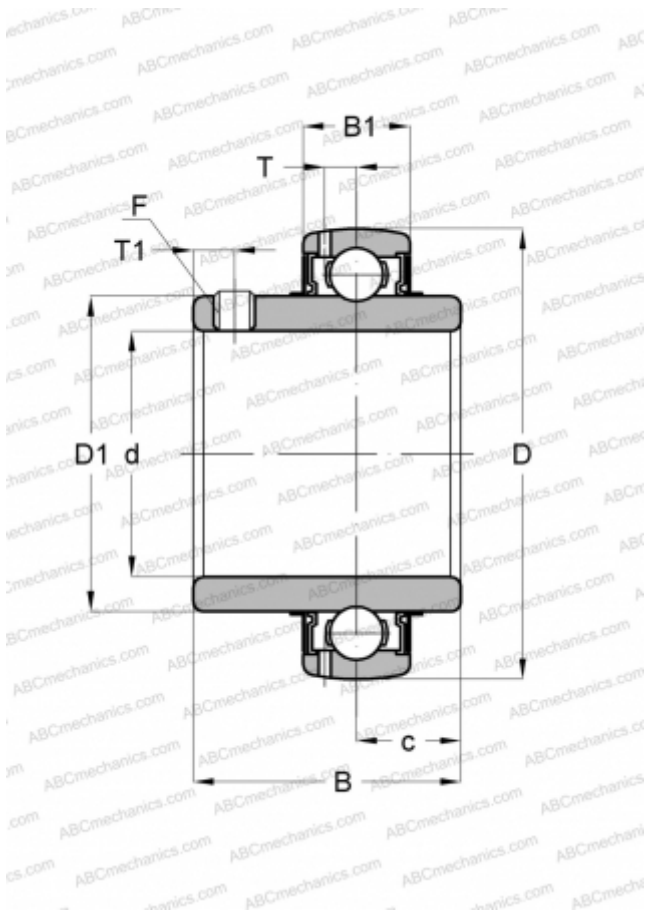

### Technical specification

#### DIMENSIONS, MM

d	75,000
D	130,000
D1	91,500
B	77,800
B1	30,000
c	33,000
T	9,200
T1	14,000
F	M12 x 1.5

#### WEIGHT, KG

2,220

#### MANUFACTURER

[ASAHI](#)