

## UC 216 ASAHI

Insert bearings

TYPE: Ball bearings, Radial insert bearings, Grub screw to inner ring, Spherical outer ring, Series UC, seals on both side

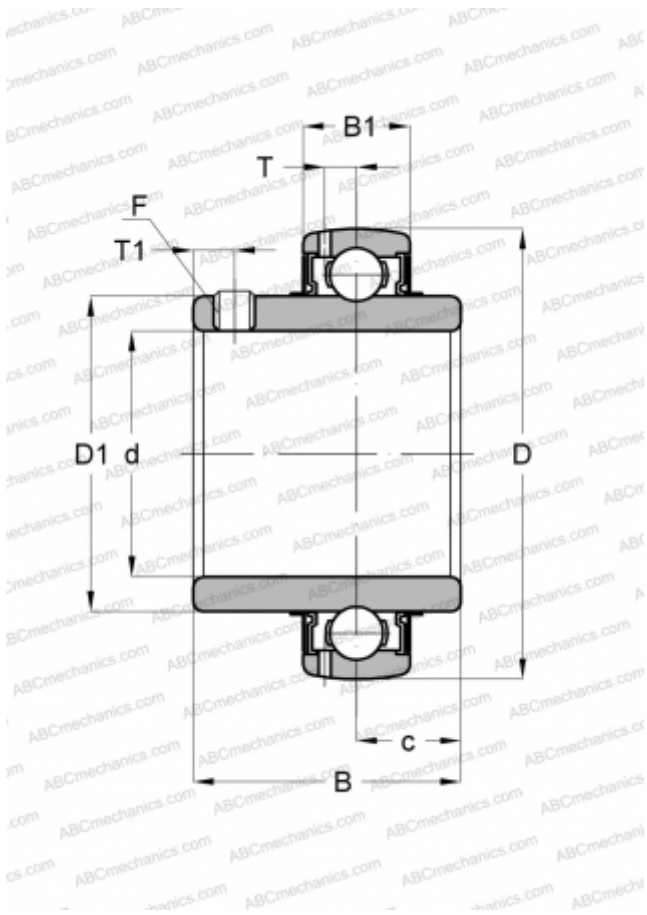

### Technical specification

#### DIMENSIONS, MM

d	80,000
D	140,000
D1	98,500
B	82,600
B1	32,000
c	33,300
T	9,600
T1	14,000
F	M12 x 1.5

#### WEIGHT, KG

2,820

#### MANUFACTURER

[ASAHI](#)