

UC 218 ASAHI

Insert bearings

TYPE: Ball bearings, Radial insert bearings, Grub screw to inner ring, Spherical outer ring, Series UC, seals on both side

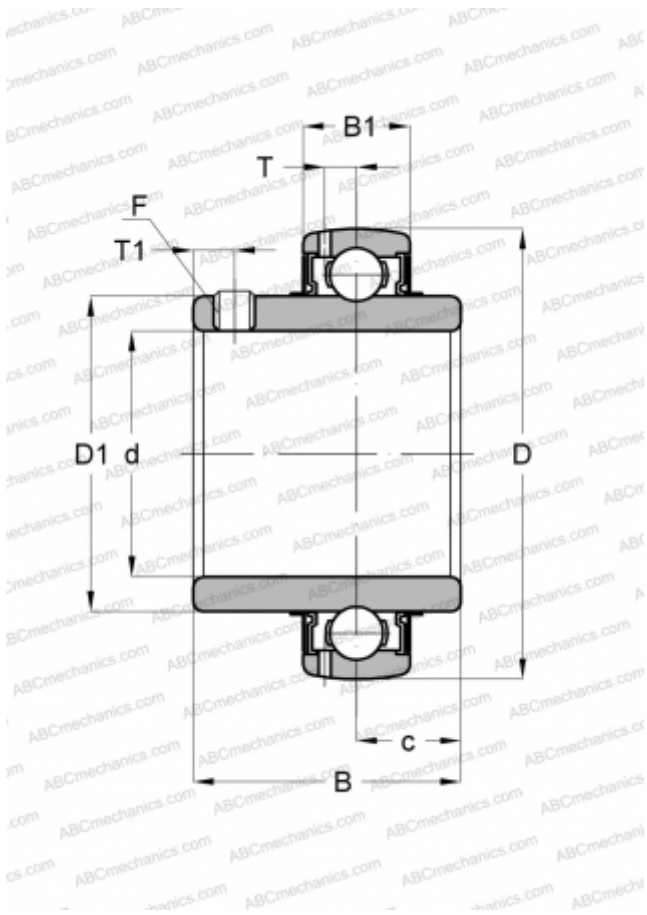

Technical specification

DIMENSIONS, MM

d	90,000
D	160,000
D1	111,500
B	96,000
B1	36,000
c	39,700
T	11,100
T1	15,000
F	M12 x 1.5

WEIGHT, KG

4,340

MANUFACTURER

[ASAHI](#)