

UC 305 ASAHI

Insert bearings

TYPE: Ball bearings, Radial insert bearings, Grub screw to inner ring, Spherical outer ring, Series UC, seals on both side

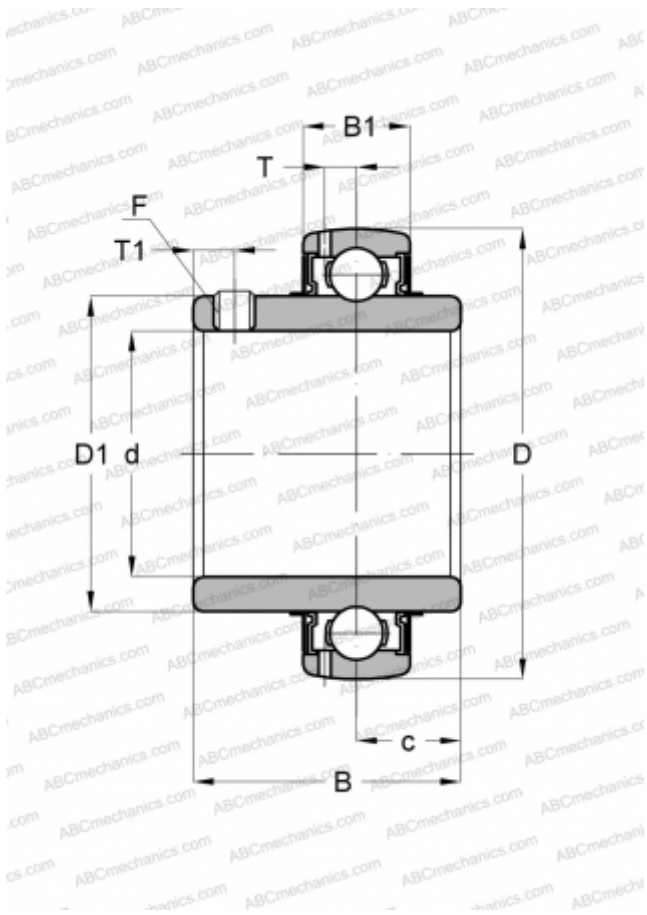

Technical specification

DIMENSIONS, MM

d	25,000
D	62,000
D1	36,900
B	38,000
B1	21,000
c	15,000
T	6,100
T1	6,000
F	M6 x 0.75

WEIGHT, KG

0,440

MANUFACTURER

[ASAHI](#)