

UC 311 ASAHI

Insert bearings

TYPE: Ball bearings, Radial insert bearings, Grub screw to inner ring, Spherical outer ring, Series UC, seals on both side

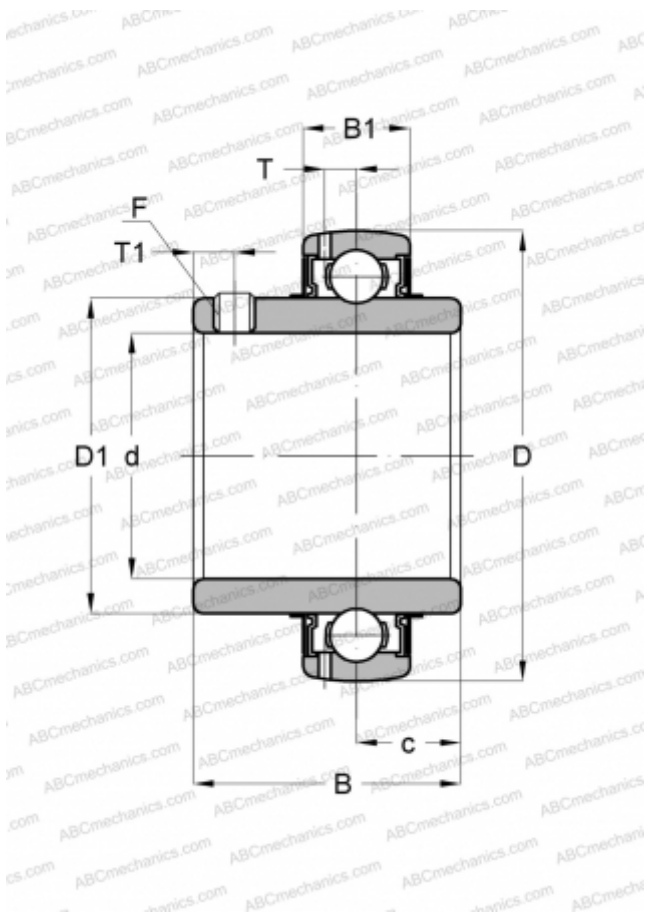

Technical specification

DIMENSIONS, MM

d	55,000
D	120,000
D1	76,500
B	66,000
B1	34,000
c	25,000
T	10,700
T1	12,000
F	M12 x 1.5

WEIGHT, KG

2,070

MANUFACTURER

[ASAHI](#)