

UC 312 ASAHI

Insert bearings

TYPE: Ball bearings, Radial insert bearings, Grub screw to inner ring, Spherical outer ring, Series UC, seals on both side

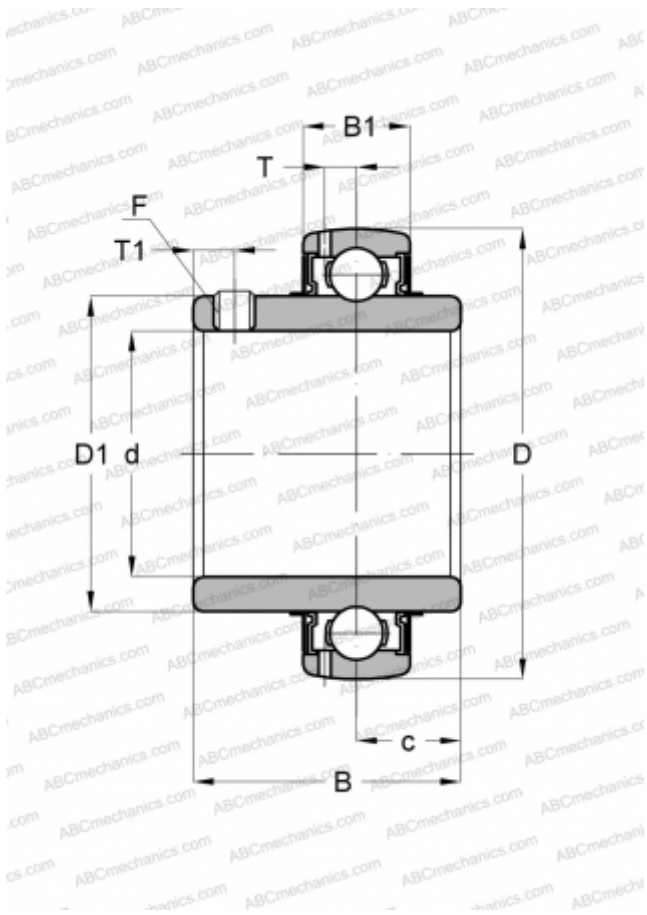

Technical specification

DIMENSIONS, MM

d	60,000
D	130,000
D1	82,500
B	71,000
B1	36,000
c	26,000
T	11,500
T1	12,000
F	M12 x 1.5

WEIGHT, KG

2,590

MANUFACTURER

[ASAHI](#)