

UC 313 ASAHI

Insert bearings

TYPE: Ball bearings, Radial insert bearings, Grub screw to inner ring, Spherical outer ring, Series UC, seals on both side

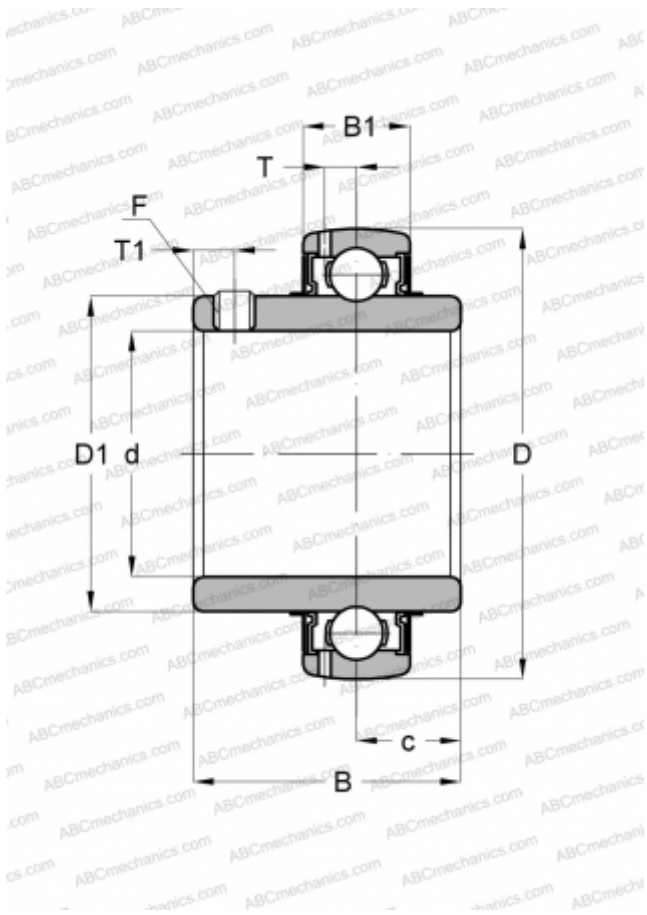

Technical specification

DIMENSIONS, MM

d	65,000
D	140,000
D1	88,500
B	75,000
B1	38,000
c	30,000
T	12,200
T1	12,000
F	M12 x 1.5

WEIGHT, KG

3,150

MANUFACTURER

[ASAHI](#)