

## UC 314 ASAHI

Insert bearings

TYPE: Ball bearings, Radial insert bearings, Grub screw to inner ring, Spherical outer ring, Series UC, seals on both side

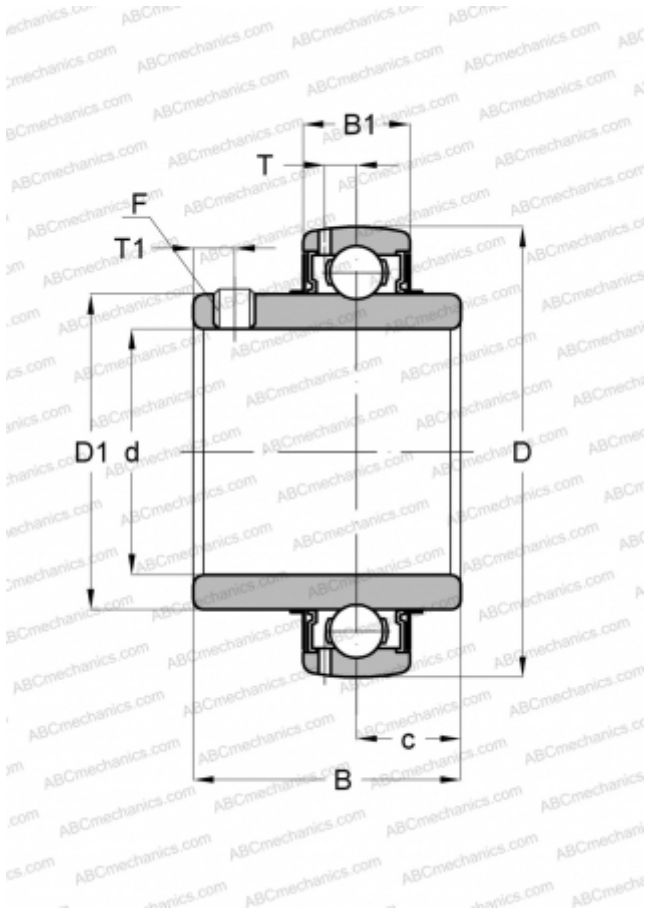

### Technical specification

#### DIMENSIONS, MM

d	70,000
D	150,000
D1	95,200
B	78,000
B1	40,000
c	33,000
T	13,000
T1	12,000
F	M12 x 1.5

#### WEIGHT, KG

3,830

#### MANUFACTURER

[ASAHI](#)