

UC 315 ASAHI

Insert bearings

TYPE: Ball bearings, Radial insert bearings, Grub screw to inner ring, Spherical outer ring, Series UC, seals on both side

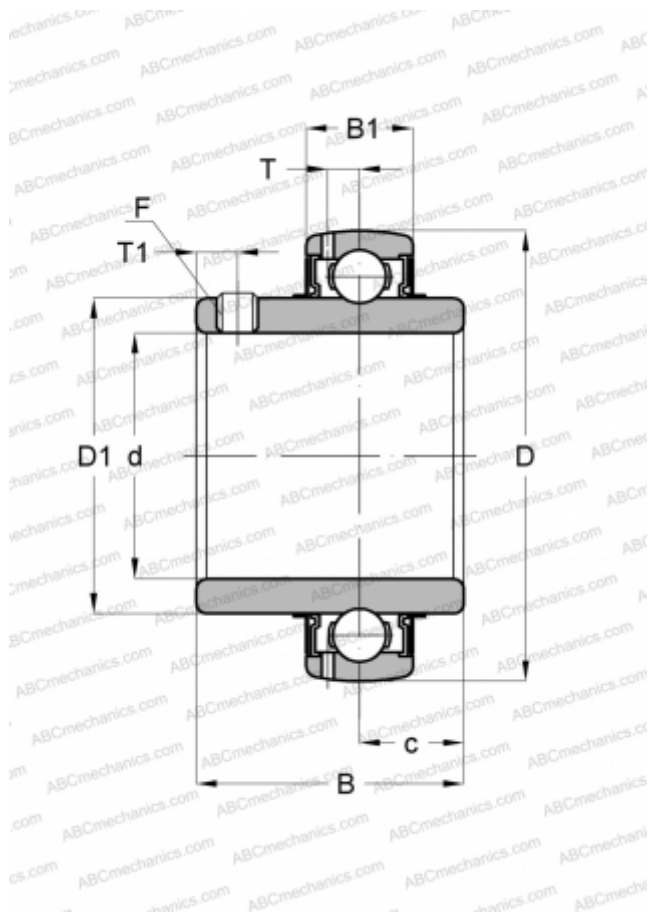

Technical specification

DIMENSIONS, MM

d	75,000
D	160,000
D1	101,500
B	82,000
B1	42,000
c	32,000
T	13,800
T1	14,000
F	M14 x 1.5

WEIGHT, KG

4,590

MANUFACTURER

[ASAHI](#)