

UC 316 ASAHI

Insert bearings

TYPE: Ball bearings, Radial insert bearings, Grub screw to inner ring, Spherical outer ring, Series UC, seals on both side

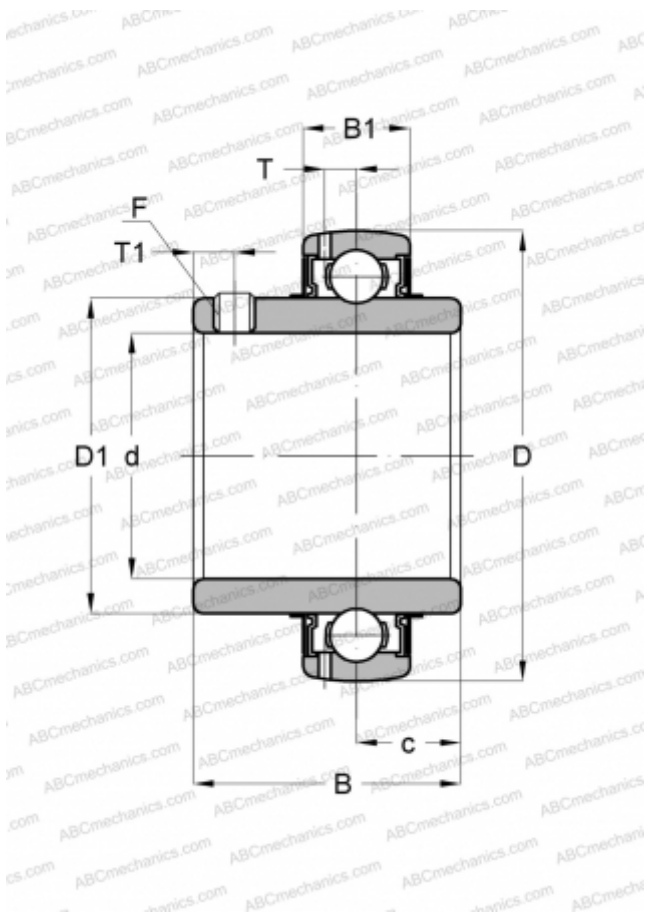

Technical specification

DIMENSIONS, MM

d	80,000
D	170,000
D1	108,000
B	86,000
B1	44,000
c	34,000
T	14,500
T1	14,000
F	M14 x 1.5

WEIGHT, KG

5,400

MANUFACTURER

[ASAHI](#)