

UC 318 ASAHI

Insert bearings

TYPE: Ball bearings, Radial insert bearings, Grub screw to inner ring, Spherical outer ring, Series UC, seals on both side

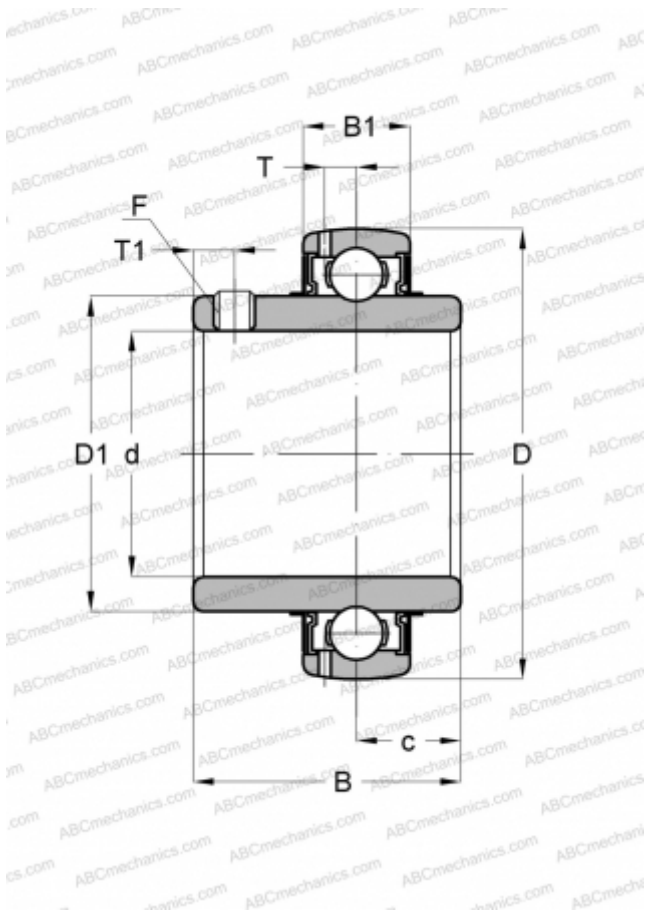

Technical specification

DIMENSIONS, MM

d	90,000
D	190,000
D1	121,000
B	96,000
B1	48,000
c	40,000
T	15,900
T1	16,000
F	M16 x 1.5

WEIGHT, KG

7,340

MANUFACTURER

[ASAHI](#)