

UC 320 ASAHI

Insert bearings

TYPE: Ball bearings, Radial insert bearings, Grub screw to inner ring, Spherical outer ring, Series UC, seals on both side

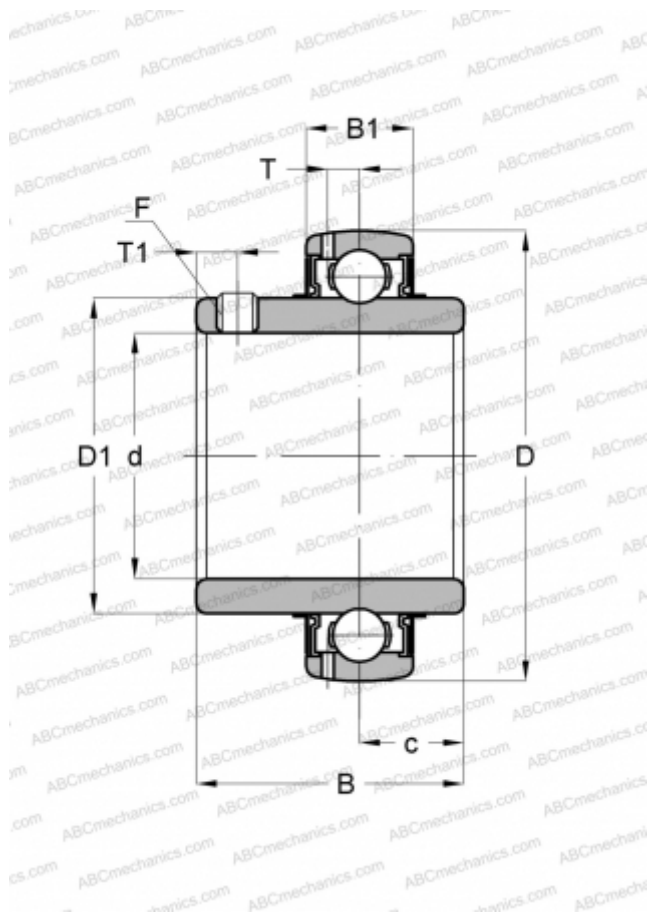

Technical specification

DIMENSIONS, MM

d	100,000
D	215,000
D1	135,500
B	108,000
B1	54,000
c	42,000
T	18,000
T1	18,000
F	M18x1.5

WEIGHT, KG

10,800

MANUFACTURER

[ASAHI](#)