

UC 324 ASAHI

Insert bearings

TYPE: Ball bearings, Radial insert bearings, Grub screw to inner ring, Spherical outer ring, Series UC, seals on both side

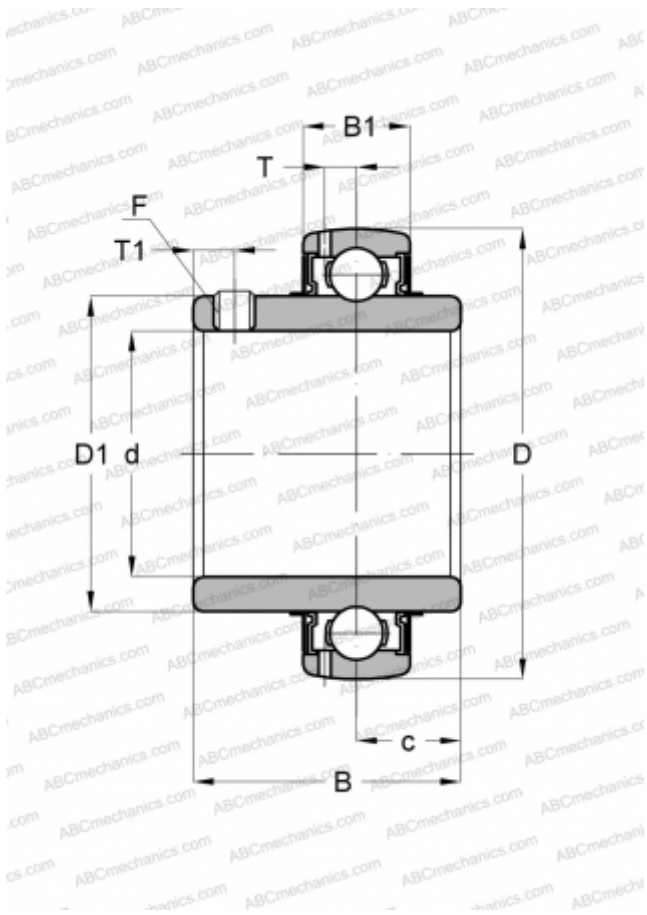

Technical specification

DIMENSIONS, MM

d	120,000
D	260,000
D1	165,000
B	126,000
B1	64,000
c	51,000
T	22,000
T1	18,000
F	M18 x 1.5

WEIGHT, KG

18,500

MANUFACTURER

[ASAHI](#)