

UC 326 ASAHI

Insert bearings

TYPE: Ball bearings, Radial insert bearings, Grub screw to inner ring, Spherical outer ring, Series UC, seals on both side

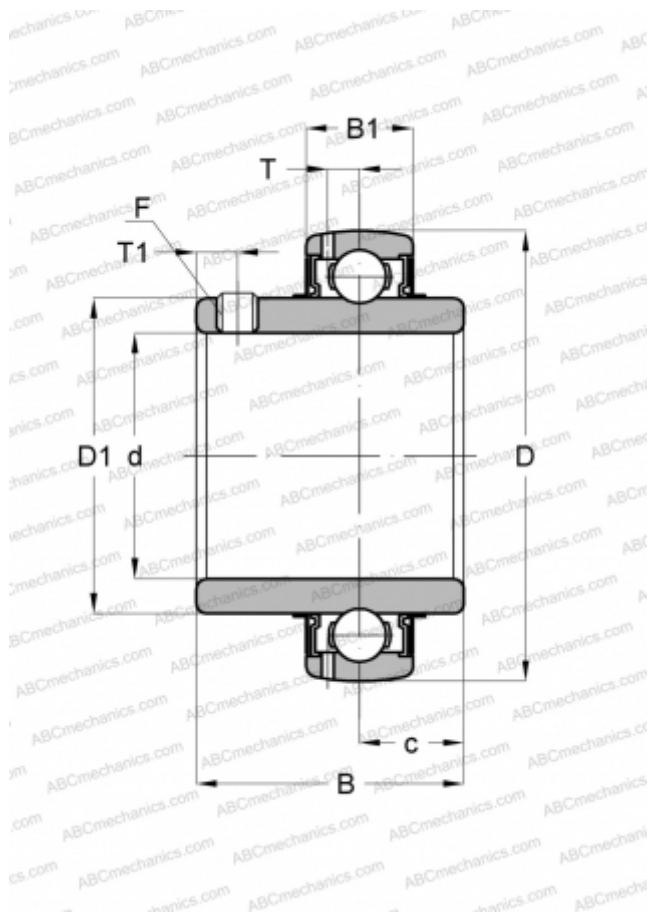

Technical specification

DIMENSIONS, MM

d	130,000
D	280,000
D1	178,000
B	135,000
B1	68,000
c	54,000
T	23,000
T1	20,000
F	M20 x 1.5

WEIGHT, KG

23,000

MANUFACTURER

[ASAHI](#)