

UC 328 ASAHI

Insert bearings

TYPE: Ball bearings, Radial insert bearings, Grub screw to inner ring, Spherical outer ring, Series UC, seals on both side

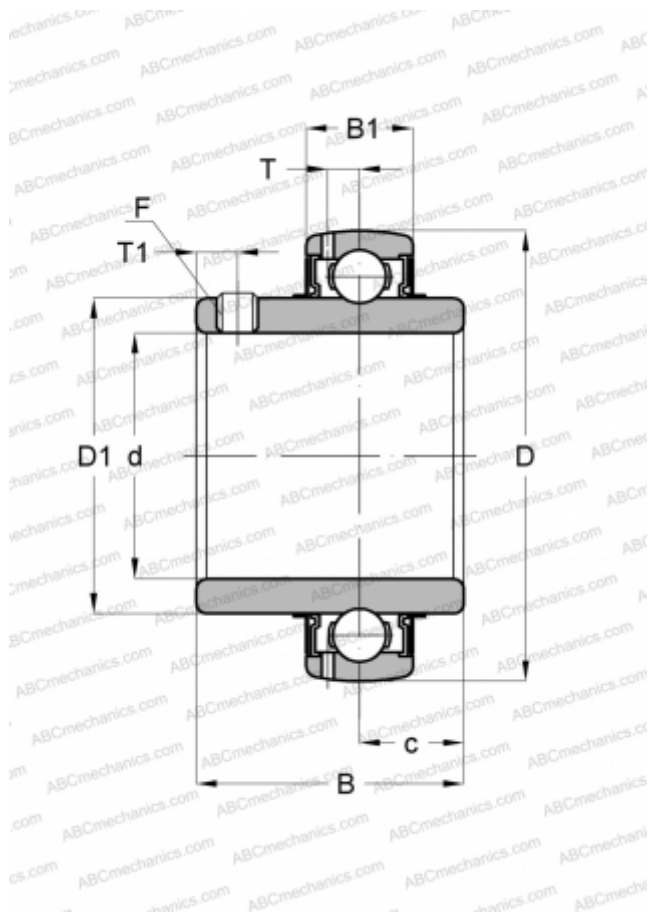

Technical specification

DIMENSIONS, MM

d	140,000
D	300,000
D1	191,500
B	145,000
B1	73,000
c	59,000
T	25,000
T1	20,000
F	M20 x 1.5

WEIGHT, KG

28,500

MANUFACTURER

[ASAHI](#)