

UC 201-8 ASAHI

Insert bearings

TYPE: Ball bearings, Radial insert bearings, Grub screw to inner ring, Spherical outer ring, Series UC, seals on both side, inch size

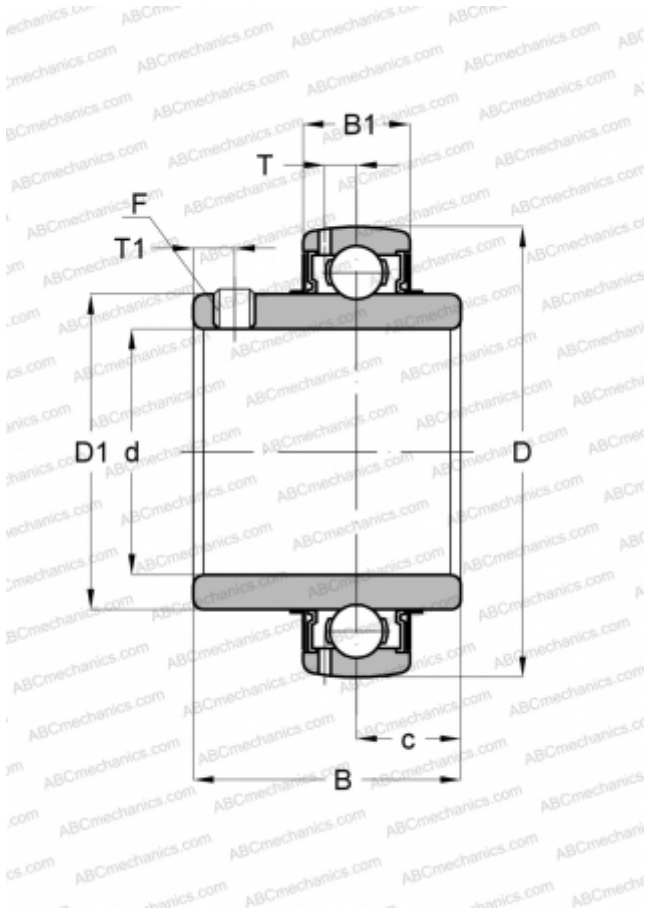

Technical specification

DIMENSIONS, MM

d	12,700
D	47,000
D1	29,007
B	30,988
B1	16,993
c	12,700
T	4,496
T1	4,496
F	1/4-28

WEIGHT, KG

0,209

MANUFACTURER

[ASAHI](#)