

## UC 202-10 ASAHI

Insert bearings

TYPE: Ball bearings, Radial insert bearings, Grub screw to inner ring, Spherical outer ring, Series UC, seals on both side, inch size

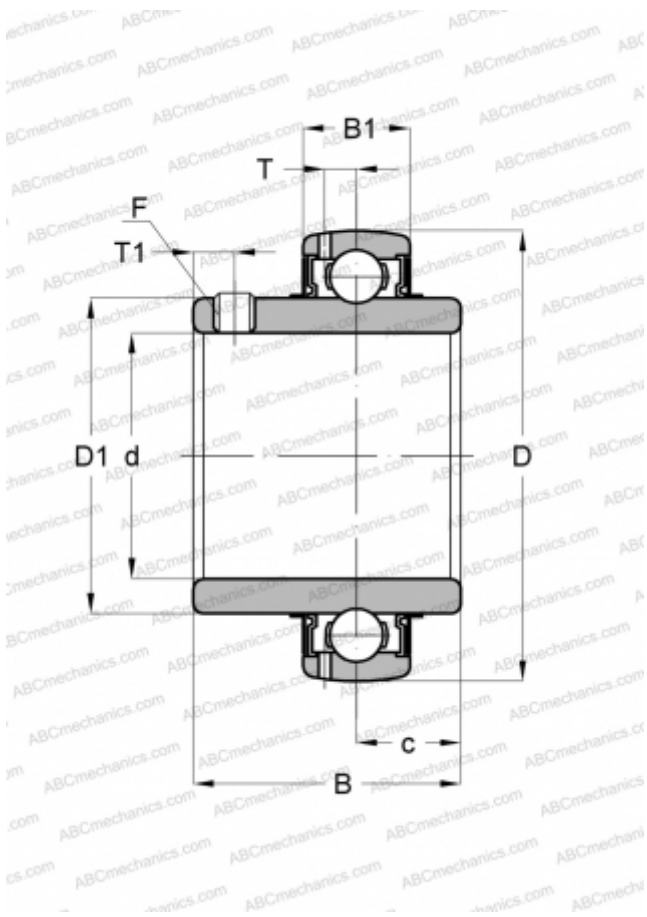

### Technical specification

#### DIMENSIONS, MM

d	15,875
D	47,000
D1	29,007
B	30,988
B1	16,993
c	12,700
T	4,496
T1	4,496
F	1/4-28

#### WEIGHT, KG

0,191

#### MANUFACTURER

[ASAHI](#)