

## UC 205-16 ASAHI

Insert bearings

TYPE: Ball bearings, Radial insert bearings, Grub screw to inner ring, Spherical outer ring, Series UC, seals on both side, inch size

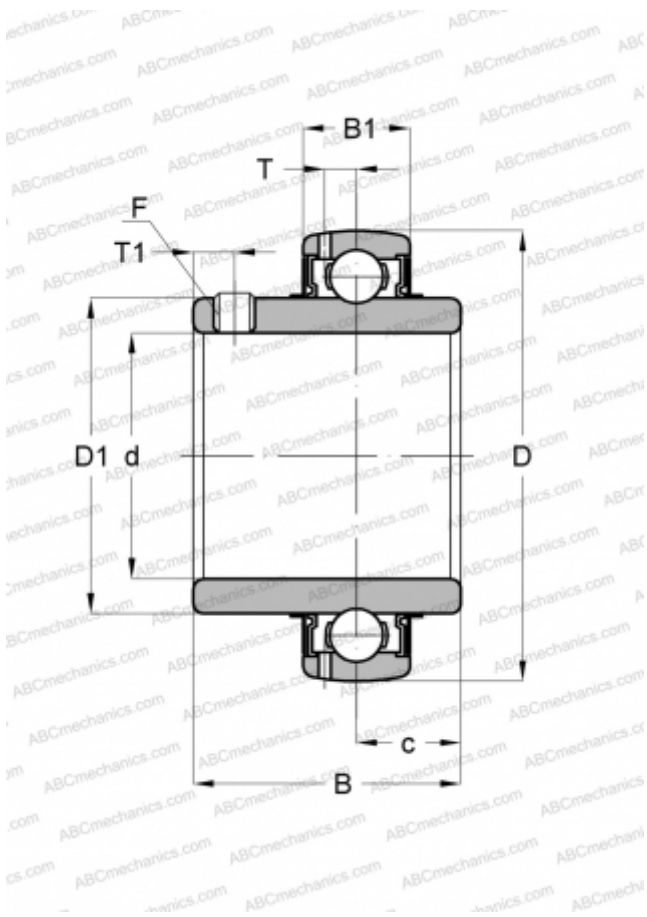

### Technical specification

#### DIMENSIONS, MM

d	25,400
D	51,999
D1	34,011
B	34,087
B1	16,993
c	14,300
T	4,496
T1	5,004
F	1/4-28

#### WEIGHT, KG

0,191

#### MANUFACTURER

[ASAHI](#)