

UC 206-19 ASAHI

Insert bearings

TYPE: Ball bearings, Radial insert bearings, Grub screw to inner ring, Spherical outer ring, Series UC, seals on both side, inch size

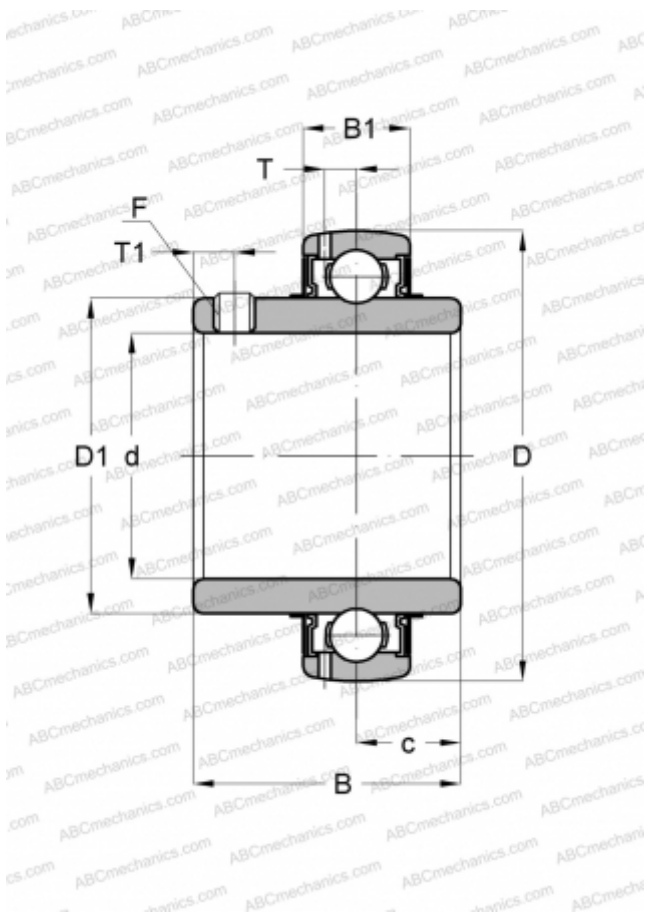

Technical specification

DIMENSIONS, MM

d	30,162
D	61,999
D1	40,488
B	38,100
B1	18,999
c	15,900
T	5,105
T1	5,004
F	1/4-28

WEIGHT, KG

0,308

MANUFACTURER

[ASAHI](#)