

## UC 207-21 ASAHI

Insert bearings

TYPE: Ball bearings, Radial insert bearings, Grub screw to inner ring, Spherical outer ring, Series UC, seals on both side, inch size

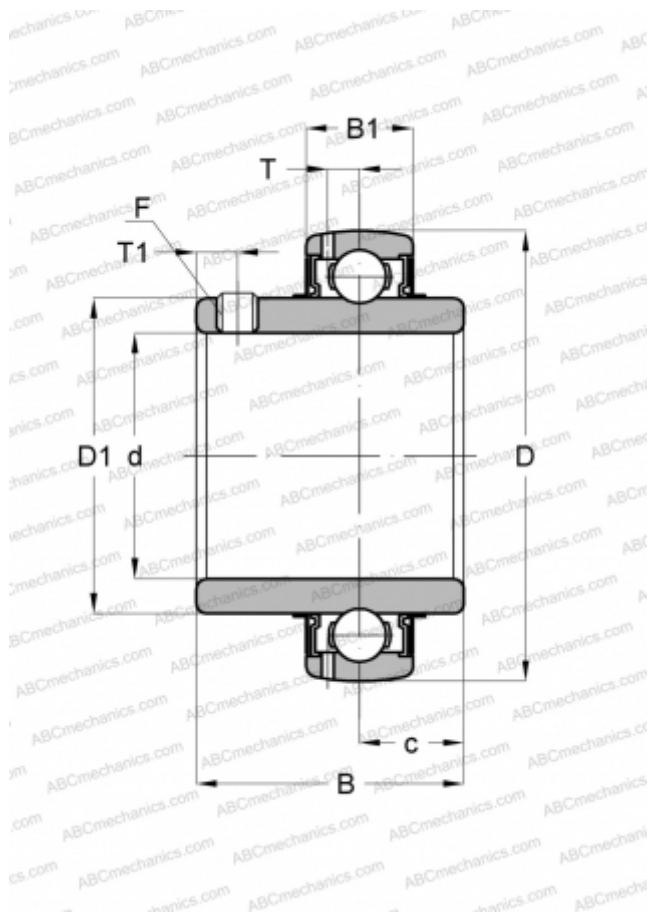

### Technical specification

#### DIMENSIONS, MM

d	33,324
D	71,999
D1	48,006
B	42,901
B1	19,990
c	17,501
T	5,791
T1	5,994
F	5/16-24

#### WEIGHT, KG

0,481

#### MANUFACTURER

[ASAHI](#)