

## UC 208-25 ASAHI

Insert bearings

TYPE: Ball bearings, Radial insert bearings, Grub screw to inner ring, Spherical outer ring, Series UC, seals on both side, inch size

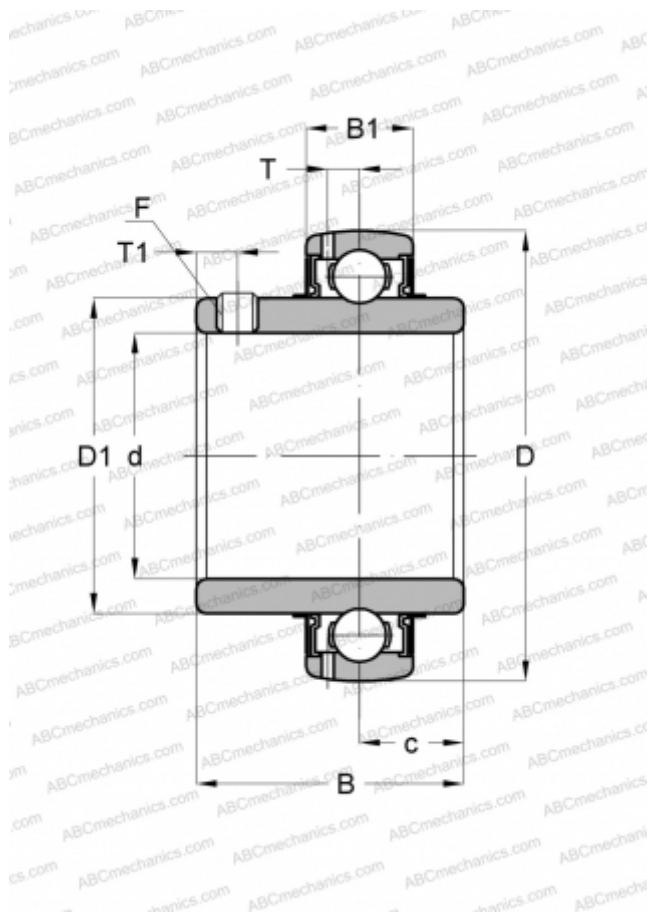

### Technical specification

#### DIMENSIONS, MM

d	39,674
D	80,000
D1	53,010
B	49,200
B1	21,006
c	18,999
T	6,198
T1	8,001
F	5/16-24

#### WEIGHT, KG

0,621

#### MANUFACTURER

[ASAHI](#)