

UC 209-27 ASAHI

Insert bearings

TYPE: Ball bearings, Radial insert bearings, Grub screw to inner ring, Spherical outer ring, Series UC, seals on both side, inch size

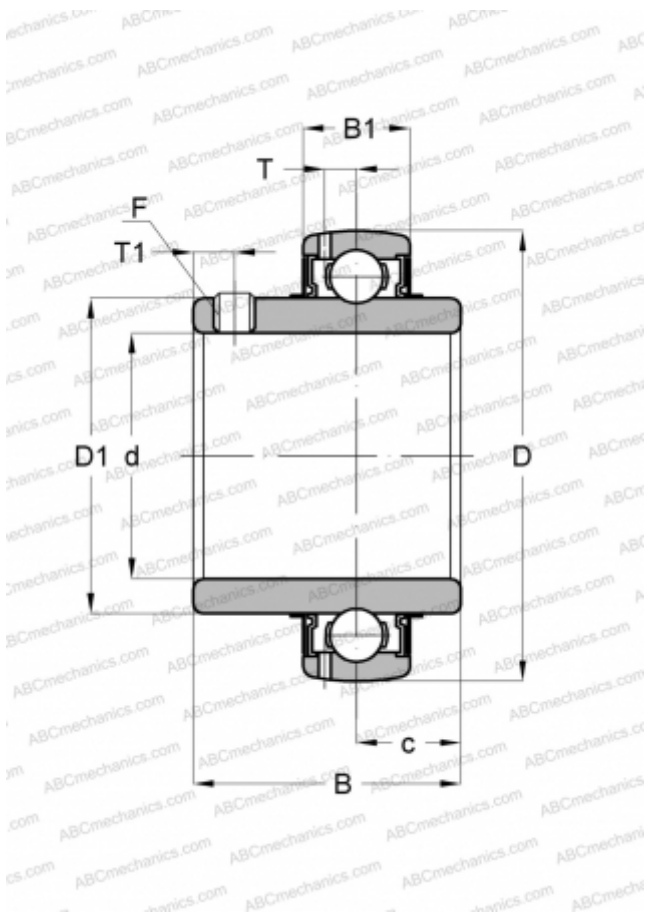

Technical specification

DIMENSIONS, MM

d	42,849
D	85,001
D1	57,302
B	49,200
B1	21,996
c	18,999
T	6,502
T1	8,001
F	5/16-24

WEIGHT, KG

0,671

MANUFACTURER

[ASAHI](#)