

UC 210-30 ASAHI

Insert bearings

TYPE: Ball bearings, Radial insert bearings, Grub screw to inner ring, Spherical outer ring, Series UC, seals on both side, inch size

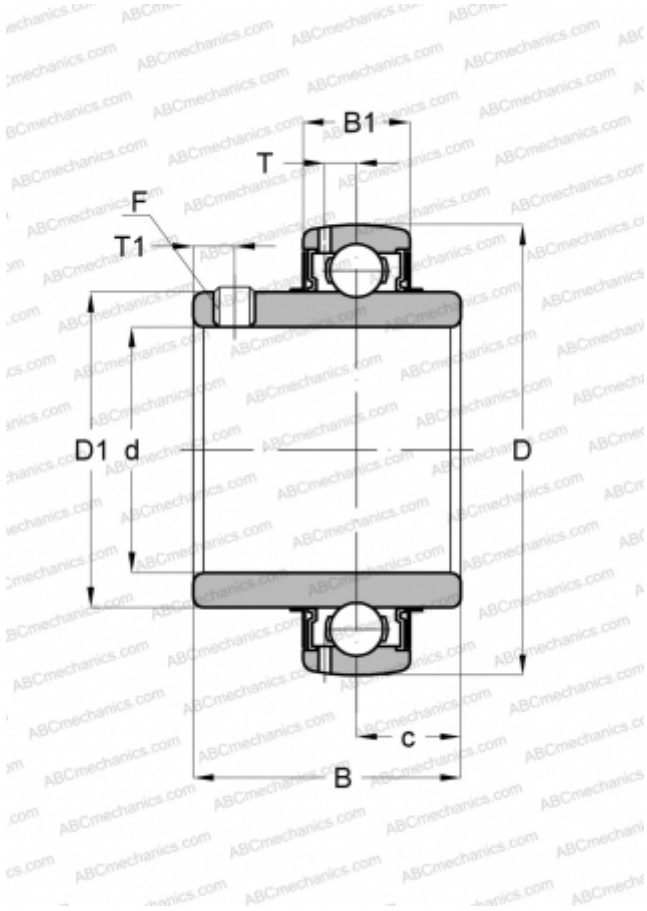

Technical specification

DIMENSIONS, MM

d	47,625
D	90,000
D1	62,992
B	51,587
B1	23,012
c	18,999
T	6,502
T1	8,992
F	3/8-24

WEIGHT, KG

0,780

MANUFACTURER

[ASAHI](#)