

UC 309-26 ASAHI

Insert bearings

TYPE: Ball bearings, Radial insert bearings, Grub screw to inner ring, Spherical outer ring, Series UC, seals on both side, inch size

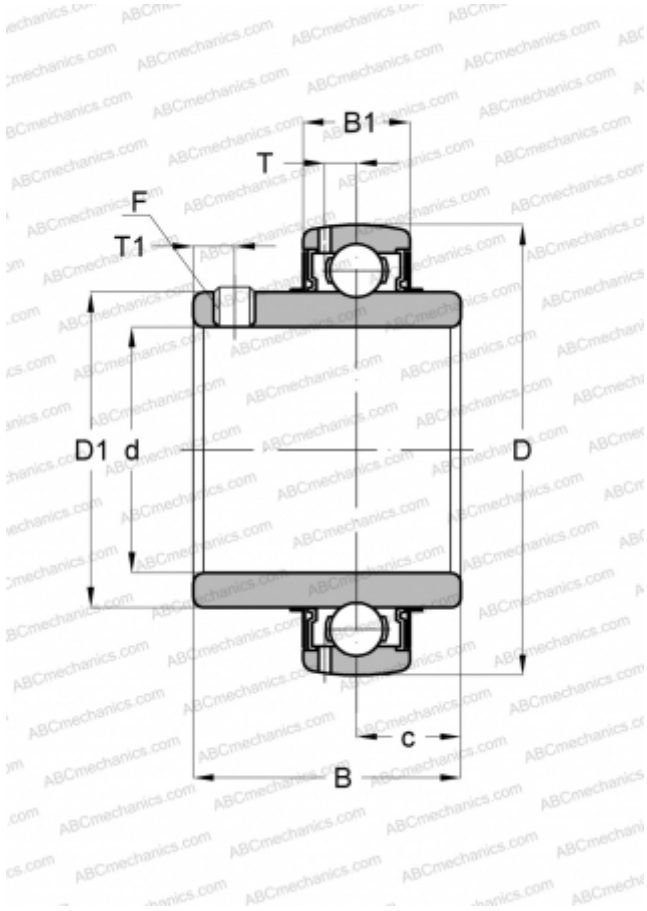

Technical specification

DIMENSIONS, MM

d	41,275
D	100,000
D1	62,992
B	56,998
B1	29,997
c	21,996
T	8,992
T1	10,008
F	3/8-24

WEIGHT, KG

1,279

MANUFACTURER

[ASAHI](#)